

VA-L Series

0.25W Unregulated Single output



Features

- 4 Pin SIL / 8 Pin DIL Package
- 1000 VDC Isolation
- Up to 3000 VDC Isolation
- Low Ripple and Noise
- Efficiency up to 77%
- -40 ~ 85°C Operation Temperature Range
- Non-Conductive Black Plastic Case
- EMI Complies With EN55022 Class B



The VA series is a family of cost effective 0.25W single output DC-DC converters. These converters achieve low cost and ultra-miniature SIP 4 pin or DIP 8 pin size. Devices are encapsulated using flame retardant resin. The models operate from input voltage of 3.3, 5, 12, 15, 24, 48 Vdc with output voltage of 3.3, 5, 7.2, 9, 12, 15, 18, 24 Vdc. High performance features include 1000Vdc~3000Vdc input/output isolation, high efficiency operation and output voltage accuracy of $\pm 3\%$ maximum. Standard features include an input range of $\pm 10\%$ tolerance and low output noise and ripple.

All specifications typical at Ta=25°C, nominal input voltage and full load unless otherwise specified

OUTPUT SPECIFICATIONS	
Voltage accuracy	$\pm 3\%$
Line regulation	$\pm 1.2\%$ / Per 1% Vin Change
Load regulation	(From 20% to 100% Load) $\pm 10\%$ (Output 3.3V Model) $\pm 20\%$
Ripple & noise (20 MHz bandwidth)(1)	100mV pk-pk
Temperature coefficient	$\pm 0.02\%/^{\circ}\text{C}$
Capacitor load(2)	See table

INPUT SPECIFICATIONS	
Voltage Range	$\pm 10\%$
Max. Input Current	See table
No-Load Input Current	See table
Input Filter	Capacitors
Input Reflected Ripple Current(3)	20mA pk-pk

GENERAL SPECIFICATIONS	
Efficiency	See table
I/O Isolation Voltage(60 sec)	
Input/Output	1000~3000Vdc
I/O Isolation Capacitance	60 pF Typ.
I/O Isolation Resistance	1000M Ohm
Switching Frequency	Variable 80kHz
Humidity	95% rel H
Reliability Calculated MTBF(MIL-HDBK-217 F)	>1.121Mhrs
Safety Standard : (designed to meet)	IEC 60950-1

ENVIRONMENT SPECIFICATIONS	
Operating Temperature	-40°C~85°C(See Derating Curve)
Maximum Case Temperature	100°C
Storage Temperature	-40°C~125°C
Cooling	Nature Convection

PHYSICAL SPECIFICATIONS	
Case Material	Non-conductive Black Plastic(UL94V-0 rated)
Pin Material	
SIP Case	0.5mm Alloy42 Solder-coated
DIP Case	$\Phi 0.5\text{mm}$ Brass Solder-coated
Potting Material	Epoxy (UL94V-0 rated)
Weight	(SIP/1.5g) (DIP/1.8g)
Dimensions	SIP Case 0.46"x0.24"x0.40" DIP Case 0.50"x0.40"x0.27"

ABSOLUTE MAXIMUM RATINGS(4)	
These are stress ratings. Exposure of devices to any of these conditions may adversely affect long-term reliability.	
Input Surge Voltage(100mS)	
3.3 Models	5 Vdc ,max.
5 Models	7 Vdc ,max.
12 Models	15 Vdc ,max.
15 Models	18 Vdc ,max.
24 Models	28 Vdc ,max.
48 Models(for SIP)	54 Vdc ,max.
Soldering Temperature (1.5mm from case 10 sec. max.)	260°C ,max.

EMC SPECIFICATIONS		
Radiated Emissions	EN55022	CLASS B
Conducted Emissions (6)	EN55022	CLASS B
ESD	IEC 61000-4-2	Perf. Criteria A
RS	IEC 61000-4-3	Perf. Criteria A
EFT (7)	IEC 61000-4-4	Perf. Criteria A
Surge (7)	IEC 61000-4-5	Perf. Criteria A
CS	IEC 61000-4-6	Perf. Criteria A
PFMF	IEC 61000-4-8	Perf. Criteria A

The information and specifications contained in this data sheet are believed to be correct at time of publication. However, MOTIEN Technologies accepts no responsibility for consequences arising from printing errors or inaccuracies. Specifications are subject to change without notice. No rights under any patent accompany the sale of any such product(s) or information contained herein.

VA - 0.25W Unregulated Single output

PART NUMBER STRUCTURE

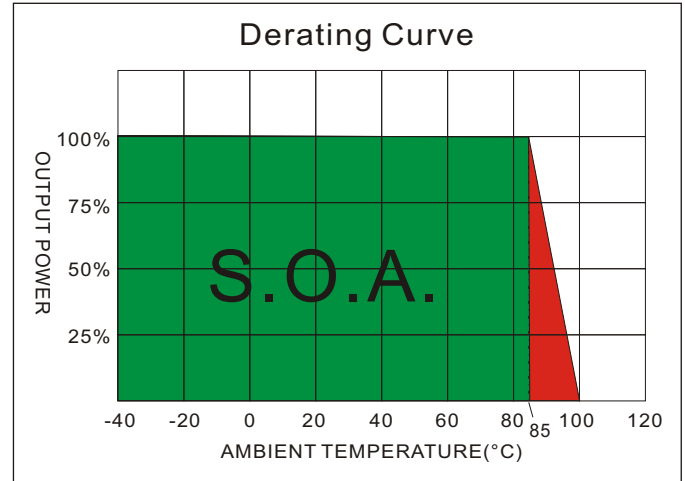
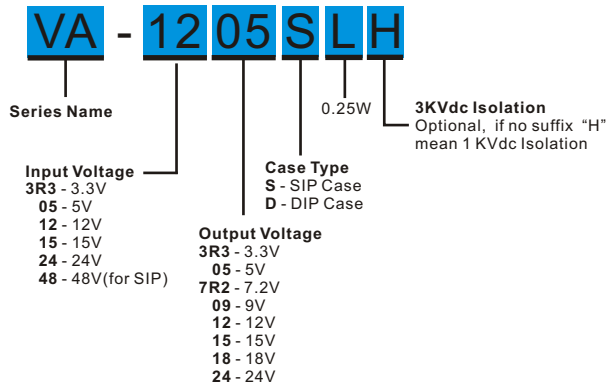

MODEL SELECTION GUIDE

MODEL NUMBER	INPUT	INPUT Current		OUTPUT	OUTPUT Current	EFFICIENCY @FL(%)	Capacitor Load(μF)
	Voltage Range (Vdc)	No-Load (mA)	Full Load (mA)	Voltage (Vdc)	Full load (mA)		
VA-3R33R3SL	3.3	30	120	3.3	75.7	63	100
VA-3R305SL	3.3	25	115	5	50	66	100
VA-3R37R2SL	3.3	25	118	7.2	34.7	64	100
VA-3R309SL	3.3	25	118	9	27.7	64	100
VA-3R312SL	3.3	32	113	12	20.8	67	100
VA-3R315SL	3.3	25	118	15	16.6	64	100
VA-3R318SL	3.3	25	115	18	13.8	66	100
VA-3R324SL	3.3	20	115	24	10.4	66	100
VA-053R3SL	5	20	78	3.3	75.7	64	100
VA-0505SL	5	17	70	5	50	71	100
VA-057R2SL	5	18	74	7.2	34.7	68	100
VA-0509SL	5	15	68	9	27.7	73	100
VA-0512SL	5	14	66	12	20.8	76	100
VA-0515SL	5	20	70	15	16.6	71	100
VA-0518SL	5	17	69	18	13.8	72	100
VA-0524SL	5	18	65	24	10.4	77	100
VA-123R3SL	12	10	32	3.3	75.7	65	100
VA-1205SL	12	12	31	5	50	67	100
VA-127R2SL	12	10	31	7.2	34.7	67	100
VA-1209SL	12	12	33	9	27.7	64	100
VA-1212SL	12	15	33	12	20.8	63	100
VA-1215SL	12	13	31	15	16.6	67	100
VA-1218SL	12	13	32	18	13.8	65	100
VA-1224SL	12	18	38	24	10.4	55	100
VA-153R3SL	15	12	26	3.3	75.7	63	100
VA-1505SL	15	8	27	5	50	62	100
VA-157R2SL	15	12	28	7.2	34.7	60	100
VA-1509SL	15	12	28	9	27.7	60	100
VA-1512SL	15	12	27	12	20.8	62	100
VA-1515SL	15	10	27	15	16.6	61	100
VA-1518SL	15	12	29	18	13.8	57	100
VA-1524SL	15	12	29	24	10.4	57	100

Suffix "H" means 3 KVdc isolation

The models listed above is just for standard type. If you need the special specification product, please contact our service member by telephone presented in shortform cover or e-mail to : sales@motien.com.tw

VA - 0.25W Unregulated Single output

MODEL NUMBER	INPUT	INPUT Current		OUTPUT	OUTPUT Current	EFFICIENCY @FL(%)	Capacitor Load(uF)
	Voltage Range (Vdc)	No-Load (mA)	Full Load (mA)	Voltage (Vdc)	Full load (mA)		
VA-243R3SL	24	8	17	3.3	75.7	60	100
VA-2405SL	24	7	17	5	50	61	100
VA-247R2SL	24	8	18	7.2	34.7	57	100
VA-2409SL	24	8	17	9	27.7	62	100
VA-2412SL	24	10	19	12	20.8	56	100
VA-2415SL	24	7	19	15	16.6	55	100
VA-2418SL	24	10	18	18	13.8	57	100
VA-2424SL	24	10	18	24	10.4	59	100
VA-483R3SL	48	8	9	3.3	75.7	55	100
VA-4805SL	48	8	10	5	50	53	100
VA-487R2SL	48	8	10	7.2	34.7	54	100
VA-4809SL	48	8	10	9	27.7	54	100
VA-4812SL	48	8	9	12	20.8	55	100
VA-4815SL	48	8	10	15	16.6	54	100
VA-4818SL	48	8	11	18	13.8	49	100
VA-4824SL	48	10	11	24	10.4	49	100
VA-3R33R3DL	3.3	25	124	3.3	75.7	61	100
VA-3R305DL	3.3	25	118	5	50	64	100
VA-3R37R2DL	3.3	25	118	7.2	34.7	64	100
VA-3R309DL	3.3	25	118	9	27.7	64	100
VA-3R312DL	3.3	25	120	12	20.8	63	100
VA-3R315DL	3.3	25	118	15	16.6	64	100
VA-3R318DL	3.3	25	115	18	13.8	66	100
VA-3R324DL	3.3	20	115	24	10.4	66	100
VA-053R3DL	5	20	83	3.3	75.7	60	100
VA-0505DL	5	15	72	5	50	69	100
VA-057R2DL	5	18	71	7.2	34.7	70	100
VA-0509DL	5	18	71	9	27.7	70	100
VA-0512DL	5	20	74	12	20.8	68	100
VA-0515DL	5	20	74	15	16.6	68	100
VA-0518DL	5	17	68	18	13.8	73	100
VA-0524DL	5	23	72	24	10.4	69	100
VA-123R3DL	12	12	31	3.3	75.7	67	100
VA-1205DL	12	10	32	5	50	65	100
VA-127R2DL	12	15	32	7.2	34.7	65	100
VA-1209DL	12	12	35	9	27.7	60	100
VA-1212DL	12	13	31	12	20.8	68	100
VA-1215DL	12	16	37	15	16.6	57	100
VA-1218DL	12	16	38	18	13.8	55	100
VA-1224DL	12	18	41	24	10.4	51	100
VA-153R3DL	15	12	26	3.3	75.7	63	100
VA-1505DL	15	10	26	5	50	63	100
VA-157R2DL	15	12	28	7.2	34.7	60	100
VA-1509DL	15	12	28	9	27.7	60	100
VA-1512DL	15	12	28	12	20.8	60	100
VA-1515DL	15	13	28	15	16.6	59	100
VA-1518DL	15	12	29	18	13.8	57	100

Suffix "H" means 3 KVdc isolation

The models listed above is just for standard type. If you need the special specification product, please contact our service member by telephone presented in shortform cover or e-mail to : sales@motien.com.tw

VA - 0.25W Unregulated Single output

MODEL NUMBER	INPUT	INPUT Current		OUTPUT	OUTPUT Current	EFFICIENCY @FL(%)	Capacitor Load(μ F)
	Voltage Range (Vdc)	No-Load (mA)	Full Load (mA)	Voltage (Vdc)	Full load (mA)		
VA-1524DL	15	12	29	24	10.4	57	100
VA-243R3DL	24	8	18	3.3	75.7	58	100
VA-2405DL	24	7	17	5	50	60	100
VA-247R2DL	24	8	18	7.2	34.7	59	100
VA-2409DL	24	8	18	9	27.7	58	100
VA-2412DL	24	10	19	12	20.8	55	100
VA-2415DL	24	7	18	15	16.6	59	100
VA-2418DL	24	10	20	18	13.8	53	100
VA-2424DL	24	10	19	24	10.4	55	100

Suffix "H" means 3 KVdc isolation

TEST CONFIGURATIONS

Input Reflected Ripple Current Test Step

Input reflected ripple current is measured through a source inductor L_{in} (12 μ H) and a source capacitor C_{in} (47 μ F, ESR<1.0 Ω at 100KHz) at nominal input and full load.

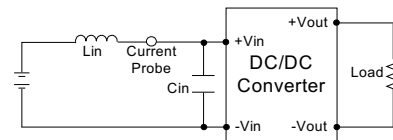

Output Ripple & Noise Measurement Test

The Scope measurement bandwidth is 20MHz .

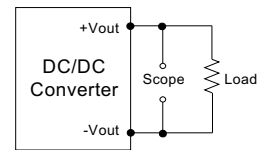

EMI Filter

Input filter components (C_1 , L , C_2 , C_3) are used to help meet conducted emissions requirement for the module.

These components should be mounted as close as possible to the module; and all leads should be minimized to decrease radiated noise.

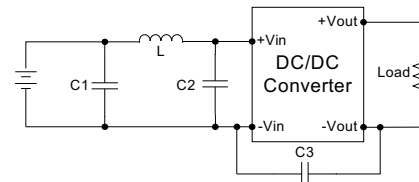

	C1	L	C2	C3
VA-3R3XXXXX	1210, 2.2 μ F/100V	18 μ H		
VA-05XXXXXX	1210, 2.2 μ F/100V	18 μ H		
VA-12XXXXXX	1210, 2.2 μ F/100V	18 μ H		
VA-15XXXXXX	1210, 2.2 μ F/100V	18 μ H		
VA-24XXXXXX	1210, 2.2 μ F/100V	18 μ H	1210, 2.2 μ F/100V	1206, 470pF/2KV
VA-48XXXXXX	Electrolytic capacitor, 10 μ F/100V	18 μ H	1210, 2.2 μ F/100V	1206, 470pF/2KV

NOTE

1. Ripple/Noise measured with 20MHz bandwidth.
2. Tested by minimal V_{in} and constant resistive load.
3. Measured Input reflected ripple current with a simulated source inductance of 12 μ H.
4. Exceeding the absolute ratings of the unit could cause damage. It is not allowed for continuous operating.
5. Operation under no-load conditions will not damage these devices, however they may not meet all listed specifications.
6. Input filter components are required to help meet conducted emission class B, which application refer to the EMI Filter of design & feature configuration.
7. An external filter capacitor is required if the module has to meet IEC61000-4-4 and IEC61000-4-5. The filter capacitor Motien suggest: Nippon - chemi - con KY series, 470 μ F/100V.

The models listed above is just for standard type. If you need the special specification product, please contact our service member by telephone presented in shortform cover or e-mail to : sales@motien.com.tw

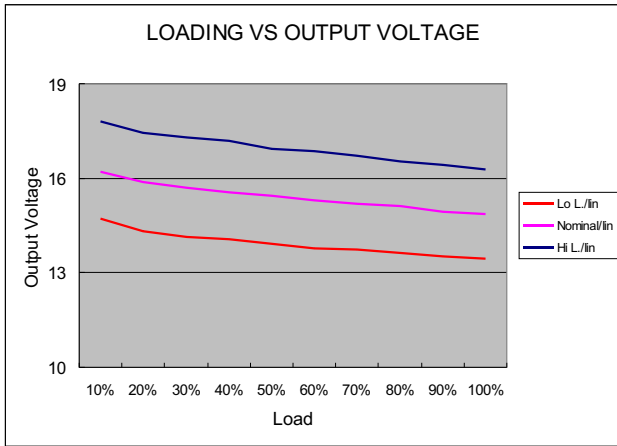

5 Models

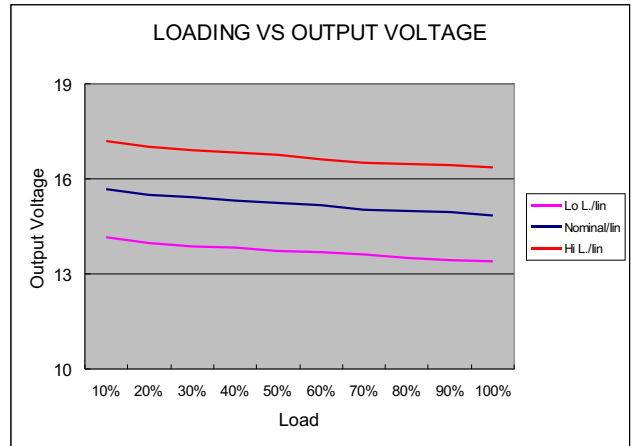

12 Models

MECHANICAL SPECIFICATIONS

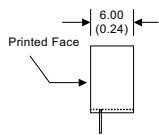
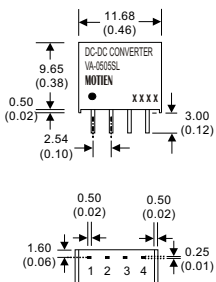

* The thickness of 48V input voltage model is 7.50(0.29)

4 Pin SIL Package

- Notes : All dimensions are typical in millimeters (inches).
1. Pin diameter: 0.5±0.05 (0.02±0.002)
 2. Pin pitch and length tolerance: ±0.35 (±0.014)
 3. Case Tolerance: ±0.5 (±0.02)

PIN CONNECTIONS	
PIN NUMBER	SINGLE
1	-V Input
2	+V Input
3	-V Output
4	+V Output

(The Pin Connection of high isolation one is the same with normal one.)

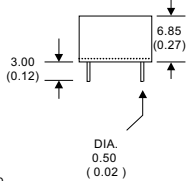
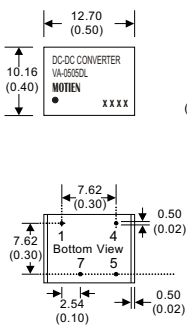

8 Pin DIL Package

- Notes : All dimensions are typical in millimeters (inches).
1. Pin diameter: 0.5±0.05 (0.02±0.002)
 2. Pin pitch and length tolerance: ±0.35 (±0.014)
 3. Case Tolerance: ±0.5 (±0.02)

PIN CONNECTIONS	
PIN NUMBER	SINGLE
1	-V Input
4	+V Input
5	+V Output
7	-V Output

(The Pin Connection of high isolation one is the same with normal one.)