

# SDS02W SDH02W SERIES

DC-DC CONVERTER

4:1 ULTRA WIDE INPUT RANGE  
UP TO 2WATTS

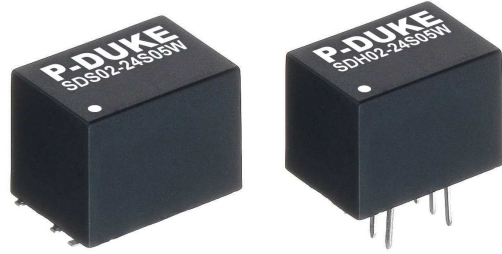

## FEATURES

- ULTRA SMALL SMD AND DIP PACKAGE, 0.52 x 0.36x 0.40 INCH WITH REGULATED
- SMD PACKAGE QUALIFIED FOR LEADFREE REFLOW SOLDER PROCESS ACCORDING IPC J-STD-020D
- NO MINIMUM LOAD REQUIRED
- CONTINUOUS SHORT CIRCUIT PROTECTION
- 1600VDC INPUT TO OUTPUT ISOLATION AND 3000VDC FOR OPTION
- SAFETY MEETS UL60950-1, EN60950-1, & IEC60950-1
- CE MARKED
- COMPLIANT TO RoHS II & REACH

## APPLICATIONS

- WIRELESS NETWORK
- TELECOM/DATACOM
- INDUSTRY CONTROL SYSTEM
- MEASUREMENT EQUIPMENT
- SEMICONDUCTOR EQUIPMENT

3000VDC ISOLATION	1600VDC ISOLATION	REMOTE CONTROL	OCP	SCP
-------------------	-------------------	----------------	-----	-----

## TECHNICAL SPECIFICATION

All specifications are typical at nominal input, full load and 25°C otherwise noted

Model Number	Input Range	Output Voltage	Output Current @Full Load	Input Current @ No Load	Efficiency	Maximum Capacitor Load
	VDC	VDC	mA	mA	%	µF
SDS(H)02-12S3P3W	4.5 ~ 18	3.3	500	25	77	2200
SDS(H)02-12S05W	4.5 ~ 18	5	400	30	80	1000
SDS(H)02-12S12W	4.5 ~ 18	12	167	30	83	550
SDS(H)02-12S15W	4.5 ~ 18	15	134	30	84	440
SDS(H)02-12S24W	4.5 ~ 18	24	83	30	84	200
SDS(H)02-12D05W	4.5 ~ 18	±5	±200	30	80	±660
SDS(H)02-12D12W	4.5 ~ 18	±12	±83	30	84	±330
SDS(H)02-12D15W	4.5 ~ 18	±15	±67	30	84	±220
SDS(H)02-24S3P3W	9 ~ 36	3.3	500	15	76	2200
SDS(H)02-24S05W	9 ~ 36	5	400	18	79	1000
SDS(H)02-24S12W	9 ~ 36	12	167	18	82	550
SDS(H)02-24S15W	9 ~ 36	15	134	18	83	440
SDS(H)02-24S24W	9 ~ 36	24	83	18	82	200
SDS(H)02-24D05W	9 ~ 36	±5	±200	18	80	±660
SDS(H)02-24D12W	9 ~ 36	±12	±83	18	82	±330
SDS(H)02-24D15W	9 ~ 36	±15	±67	18	81	±220
SDS(H)02-48S3P3W	18 ~ 75	3.3	500	8	75	2200
SDS(H)02-48S05W	18 ~ 75	5	400	8	81	1000
SDS(H)02-48S12W	18 ~ 75	12	167	11	83	550
SDS(H)02-48S15W	18 ~ 75	15	134	11	82	440
SDS(H)02-48S24W	18 ~ 75	24	83	11	82	200
SDS(H)02-48D05W	18 ~ 75	±5	±200	11	79	±660
SDS(H)02-48D12W	18 ~ 75	±12	±83	11	82	±330
SDS(H)02-48D15W	18 ~ 75	±15	±67	11	82	±220

## PART NUMBER STRUCTURE

<b>SDS02</b> - <b>48</b> <b>S</b> <b>05</b> <b>W</b> <b>H</b>					
Series Name	Input Voltage (VDC)	Output Quantity	Output Voltage (VDC)	Input Range	Isolation Option
SDS: SMD type SDH: DIP type	12: 4.5~18 24: 9~36 48: 18~75	S: Single	3P3: 3.3 05: 5 12: 12 15: 15 24: 24	4:1	□: 1600VDC Isolation H: 3000VDC Isolation
		D: Dual	05: ±5 12: ±12 15: ±15		

**INPUT SPECIFICATIONS**

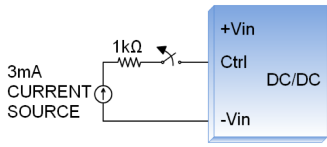
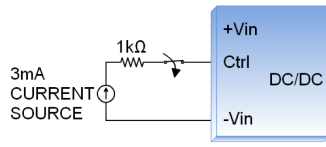
Parameter	Conditions	Min.	Typ.	Max.	Unit
Operating input voltage range	12Vin(nom)	4.5	12	18	VDC
	24Vin(nom)	9	24	36	
	48Vin(nom)	18	48	75	
Start up time	Constant resistive load Power up Remote ON/OFF		5 5	10 10	ms
Input surge voltage	1 second, max.			25 50 100	VDC
Input reflected ripple current <sup>(1)</sup>	12Vin(nom)		20		mAp-p
	24Vin(nom)		20		
	48Vin(nom)		20		
Input filter			Capacitor type		
Remote ON/OFF	DC-DC ON Ctrl pin applied current via 1kΩ	Open or high impedance			mA
	DC-DC OFF Remote off input current	2.0	3.0	4.0 2.5	mA
<p>Application circuit</p> <p>DC-DC ON</p>  <p>DC-DC OFF</p> 					

**OUTPUT SPECIFICATIONS**

Parameter	Conditions	Min.	Typ.	Max.	Unit
Voltage accuracy		-1.0		+1.0	%
Line regulation	Low Line to High Line at Full Load	-0.2		+0.2	%
Load regulation	No Load to Full Load	-1.0		+1.0	%
		-1.0		+1.0	
	10% Load to 90% Load	-0.5		+0.5	
Cross regulation	Asymmetrical load 25%/100% FL	-0.8		+0.8	
Ripple and noise	Measured by 20MHz bandwidth		50		mVp-p
Temperature coefficient		-0.02		+0.02	%/°C
Transient response recovery time	25% load step change		500		μs
Short circuit protection		Continuous, automatic recovery			

**GENERAL SPECIFICATIONS**

Parameter	Conditions	Min.	Typ.	Max.	Unit
Isolation voltage	1 minute	1600			VDC
		3000			
Isolation resistance	500VDC	1			GΩ
Isolation capacitance				50	pF
				50	
Switching frequency		100			kHz
Design meets					UL60950-1 EN60950-1 IEC60950-1
Case material					Non-conductive black plastic
Base material					Non-conductive black plastic
Potting material					Silicone (UL94 V-0)
Weight					2.7g (0.10oz)
MTBF	MIL-HDBK-217F, Full load				6.204 x 10 <sup>6</sup> hrs

**ENVIRONMENTAL SPECIFICATIONS**

Parameter	Conditions	Min.	Typ.	Max.	Unit
Operating ambient temperature	Without derating	-40		80	°C
	With derating	80		+105	
Storage temperature range		-55		+125	°C
Thermal shock					MIL-STD-810F
Vibration					MIL-STD-810F
Relative humidity					5% to 95% RH

**EMC SPECIFICATIONS**

Parameter	Conditions	Level
EMI (1)	EN55022	Class A, Class B
ESD	EN61000-4-2 Air ± 8kV Contact ± 6kV	Perf. Criteria A
Radiated immunity	EN61000-4-3 10 V/m	Perf. Criteria A
Fast transient (2)	EN61000-4-4 ± 2kV	Perf. Criteria A
Surge (2)	EN61000-4-5 ± 1kV	Perf. Criteria A
Conducted immunity	EN61000-4-6 10 Vr.m.s	Perf. Criteria A

**Note:**

- The standard modules meet EMI Class A or Class B and input reflected ripple current with external components. For further information, please contact with P-DUKE.
- An external input filter capacitor is required if the module has to meet EN61000-4-4, EN61000-4-5. The filter capacitor Power Mate suggest: Nippon chemi-con KY series, 220 µF/100V.

**CAUTION:** This power module is not internally fused. An input line fuse must always be used.

**CHARACTERISTIC CURVE**

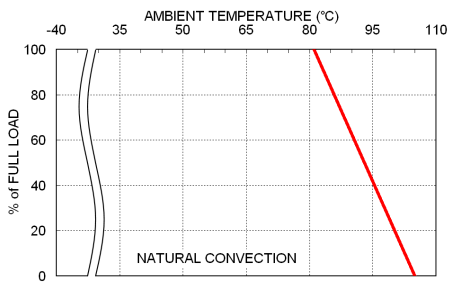

SDS(H)02-48S05W Derating Curve

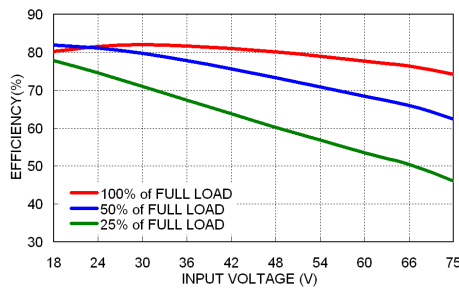

SDS(H)02-48S05W Efficiency vs. Input Voltage

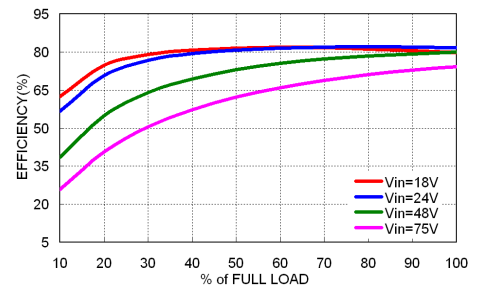

SDS(H)02-48S05W Efficiency vs. Output Current

**MECHANICAL DRAWING**

**SDS02W: SMD TYPE**

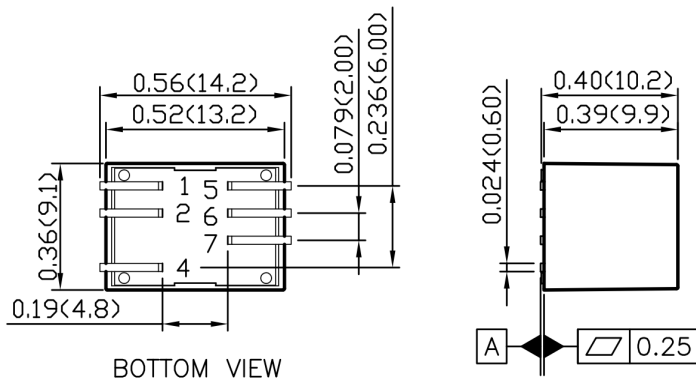

**PIN CONNECTION**

PIN	SINGLE	DUAL
1	+Vin	+Vin
2	-Vin	-Vin
4	Ctrl	Ctrl
5	NC	-Vout
6	-Vout	Common
7	+Vout	+Vout

- All dimensions in inch (mm)
- Tolerance :x.xx±0.02 (x.x±0.5)  
x.xxx±0.01 (x.xx±0.25)
- Pin pitch tolerance ±0.01 (0.25)
- Pin dimension tolerance ±0.004(0.1)

**SDH02W: DIP TYPE**

