

VG-2W Series



2W 2:1 Regulated Single & Dual output

Features

- Wide 2:1 Input Range
- Full SMD Technology
- 1500 VDC Isolation, Up to 3500 VDC
- Continuous Short Circuit Protection
- Efficiency up to 78%
- -40 ~ 85°C Operation Temperature Range
- Metal Case Standard, Optional Plastic Case



The VG series is a family of cost effective 2W single & dual output DC-DC converters. These converters are consisted with Nickel-coated copper in a 24-pin DIL package with high performance features such as 1500 VDC ~ 3500VDC input/output isolation voltage, continuous short circuit protection with automatic restart and tight line / load regulation. Devices are encapsulated using flame retardant resin. Input voltages of 12,24 and 48 with output voltage of 3.3,5,9,12,15, 24, ±3.3, ±5, ±9, ±12, ±15 and ±24 Vdc. High performance features include high efficiency operation up to 78% and output voltage accuracy of ±1% maximum.

All specifications typical at Ta=25°C, nominal input voltage and full load unless otherwise specified

OUTPUT SPECIFICATIONS	
Voltage accuracy	±1%
Line regulation	±0.5%
Load regulation	±0.5%
	(Output 3.3V / ±3.3V Model) ±1.5%
Ripple & noise (20 MHz bandwidth)(1)	60mV pk-pk
Short circuit protection	Indefinite(Automatic Recovery)
Temperature coefficient	±0.02%/°C
Capacitor load(2)	See table

INPUT SPECIFICATIONS	
Voltage Range	See table
Max. Input Current	See table
No-Load Input Current	See table
Input Filter	PI Type
Input Reflected Ripple Current(3)	35mA pk-pk

GENERAL SPECIFICATIONS	
Efficiency	See table, typ.
I/O Isolation Voltage(3 sec)	
Input/Output	1500~3500Vdc
Metal Case/Input & Output	1000Vdc
I/O Isolation Capacitance	470 pF, typ.
I/O Isolation Resistance	1000M Ohm
Switching Frequency	266kHz, typ.
Humidity	95% rel H
Reliability Calculated MTBF(MIL-HDBK-217 F)	>1.121 Mhrs
Safety Standard : (designed to meet)	IEC 60950-1

PHYSICAL SPECIFICATIONS	
Case Material	Nickel-coated Copper
	Non-conductive Black Plastic(UL94V-0 rated)
Base Material	Non-conductive Black Plastic(UL94V-0 rated)
Pin Material	Ø0.5mm Brass Solder-coated
Potting Material	Epoxy (UL94V-0 rated)
Weight	17.0g(Metal Case)/13.5g(Plastic Case)
Dimensions	1.25"x0.8"x0.4"

ENVIRONMENT SPECIFICATIONS	
Operating Temperature	-40°C~85°C(See Derating Curve)
Maximum Case Temperature	100°C
Storage Temperature	-40°C~125°C
Cooling	Nature Convection

ABSOLUTE MAXIMUM RATINGS(4)	
These are stress ratings. Exposure of devices to any of these conditions may adversely affect long-term reliability.	
Input Surge Voltage(100mS)	
12 Models	24 Vdc, max.
24 Models	40 Vdc, max.
48 Models	80 Vdc, max.
Soldering Temperature (1.5mm from case 10sec.max.)	260°C, max.

The information and specifications contained in this data sheet are believed to be correct at time of publication. However, MOTIEN Technologies accepts no responsibility for consequences arising from printing errors or inaccuracies. Specifications are subject to change without notice. No rights under any patent accompany the sale of any such product(s) or information contained herein.

VG - 2W 2:1 Regulated Single & Dual output

PART NUMBER STRUCTURE

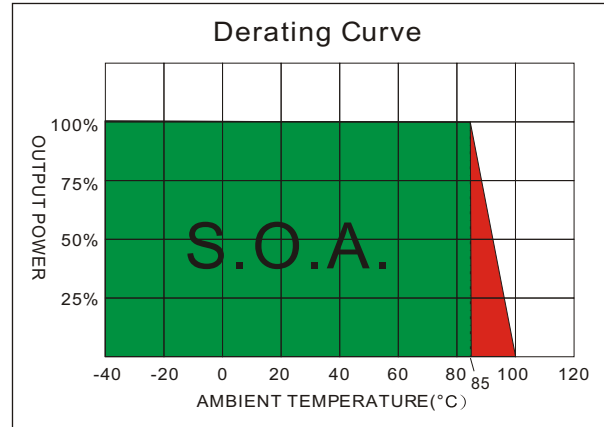
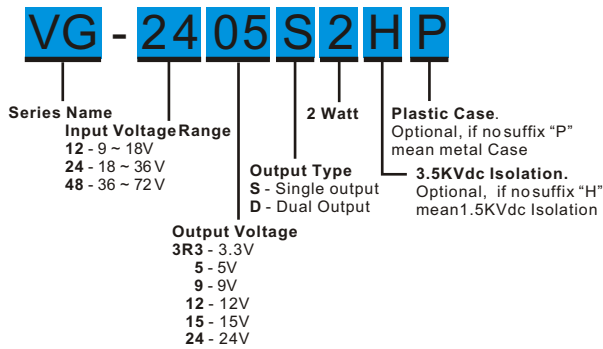

MODEL SELECTION GUIDE

MODEL NUMBER	INPUT Voltage Range (Vdc)	INPUT Current		OUTPUT Voltage (Vdc)	OUTPUT Current		EFFICIENCY @FL(%)	Capacitor Load(uF)
		No-Load (mA)	Full Load (mA)		Min. load (mA)	Full load (mA)		
VG-123R3S2	9-18	30	223	3.3	0	600	74	680
VG-1205S2	9-18	30	222	5	0	400	75	680
VG-1209S2	9-18	30	219	9	0	222	76	330
VG-1212S2	9-18	30	219	12	0	167	76	220
VG-1215S2	9-18	30	219	15	0	133	76	100
VG-1224S2	9-18	30	219	24	0	83	76	33
VG-123R3D2	9-18	30	229	±3.3	0	±300	72	±330
VG-1205D2	9-18	30	219	±5	0	±200	75	±330
VG-1209D2	9-18	30	219	±9	0	±111	76	±100
VG-1212D2	9-18	30	219	±12	0	±83	76	±47
VG-1215D2	9-18	30	219	±15	0	±67	76	±33
VG-1224D2	9-18	30	219	±24	0	±42	76	±22
VG-243R3S2	18-36	20	109	3.3	0	600	76	680
VG-2405S2	18-36	20	107	5	0	400	78	680
VG-2409S2	18-36	20	107	9	0	222	78	330
VG-2412S2	18-36	20	107	12	0	167	78	220
VG-2415S2	18-36	20	107	15	0	133	78	100
VG-2424S2	18-36	20	107	24	0	83	78	33
VG-243R3D2	18-36	20	112	±3.3	0	±300	74	±330
VG-2405D2	18-36	20	109	±5	0	±200	76	±330
VG-2409D2	18-36	20	107	±9	0	±111	78	±100
VG-2412D2	18-36	20	107	±12	0	±83	78	±47
VG-2415D2	18-36	20	107	±15	0	±67	78	±33
VG-2424D2	18-36	20	107	±24	0	±42	78	±22
VG-483R3S2	36-72	12	56	3.3	0	600	74	680
VG-4805S2	36-72	12	56	5	0	400	75	680
VG-4809S2	36-72	12	56	9	0	222	75	330
VG-4812S2	36-72	12	56	12	0	167	75	220
VG-4815S2	36-72	12	56	15	0	133	75	100
VG-4824S2	36-72	12	56	24	0	83	75	33

Suffix "H" means 3.5KVdc isolation

Suffix "P" means Plastic case instead of standard Metal Case

VG - 2W 2:1 Regulated Single & Dual output

MODEL NUMBER	INPUT Voltage Range (Vdc)	INPUT Current		OUTPUT Voltage (Vdc)	OUTPUT Current		EFFICIENCY @FL(%)	Capacitor Load(uF)
		No-Load (mA)	Full Load (mA)		Min. load (mA)	Full load (mA)		
VD-483R3D2	36-72	12	56	±3.3	0	±300	74	±330
VD-4805D2	36-72	12	56	±5	0	±200	75	±330
VD-4809D2	36-72	12	56	±9	0	±111	75	±100
VD-4812D2	36-72	12	56	±12	0	±83	75	±47
VD-4815D2	36-72	12	56	±15	0	±67	75	±33
VD-4824D2	36-72	12	56	±24	0	±42	75	±22

Suffix "H" means 3.5KVdc isolation

Suffix "P" means Plastic case instead of standard Metal Case

NOTE

1. Ripple/Noise measured with a 1uF ceramic capacitor.
2. Test by nominal input voltage and constant resistor load.
3. Measured Input reflected ripple current with a simulated source inductance of 12uH.
4. Exceeding the absolute ratings of the unit could cause damage. It is not allowed for continuous operating.

TEST CONFIGURATIONS

Input Reflected Ripple Current Test Step

Input reflected ripple current is measured through a source inductor L_{in} (12uH) and a source capacitor C_{in} (47uF, ESR<1.0Ω at 100KHz) at nominal input and full load.

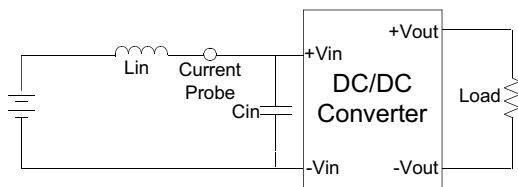

Output Ripple & Noise Measurement Test

Use a capacitor C_{out} (1.0uF) measurement. The Scope measurement bandwidth is 0-20MHz.

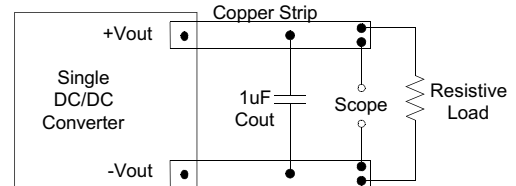

ELECTRICAL CHARACTERISTIC CURVES

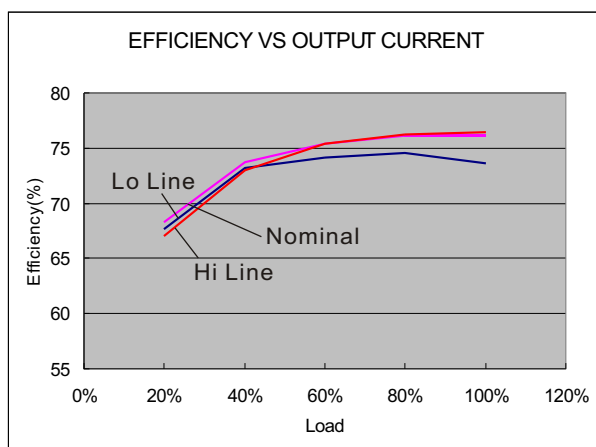

12 Models

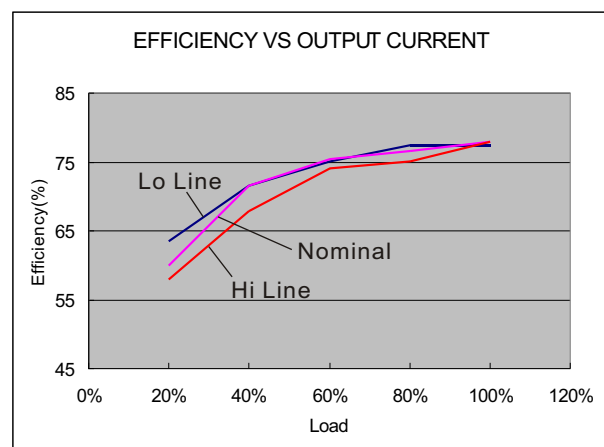

24 Models

VG - 2W 2:1 Regulated Single & Dual output

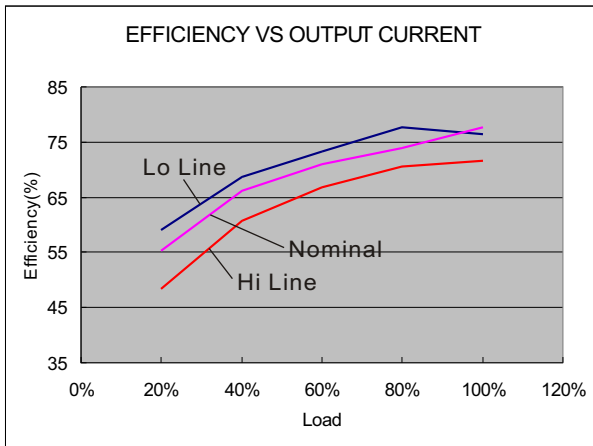

48 Models

MECHANICAL SPECIFICATIONS

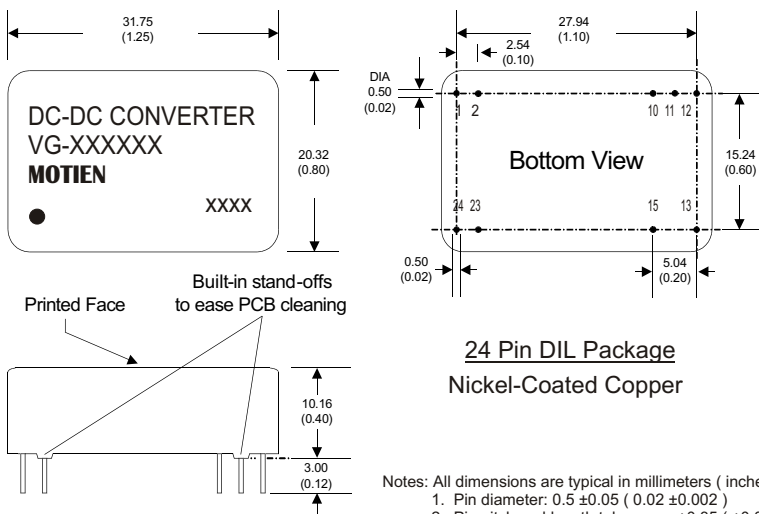

PIN CONNECTIONS		
PIN NUMBER	SINGLE	DUAL
1	+V Input	+V Input
2	+V Input	+V Input
10	N.C.	Common
11	N.C.	Common
12	-V Output	N.C.
13	+V Output	-V Output
15	N.C.	+V Output
23	-V Input	-V Input
24	-V Input	-V Input

(The Pin Connection of high isolation one is the same with normal one.)

MECHANICAL SPECIFICATIONS

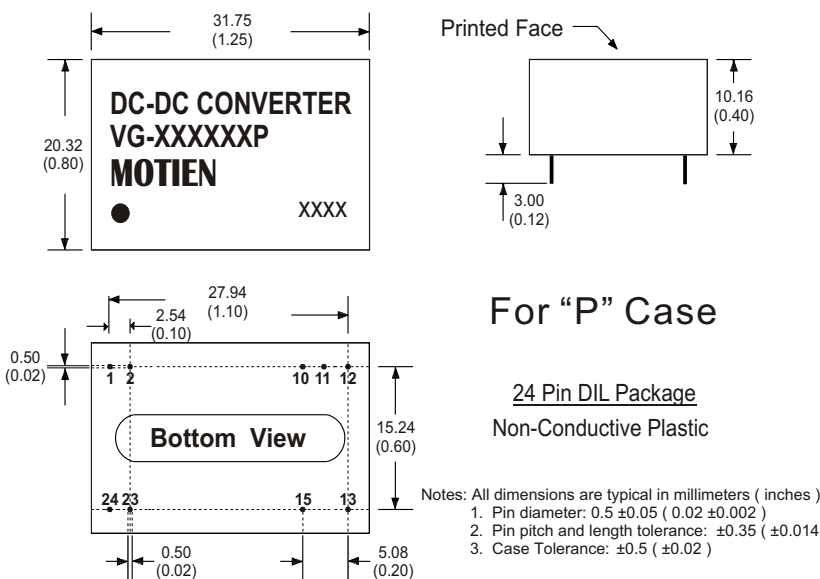

PIN CONNECTIONS		
PIN NUMBER	SINGLE	DUAL
1	+V Input	+V Input
2	+V Input	+V Input
10	N.C.	Common
11	N.C.	Common
12	-V Output	N.C.
13	+V Output	-V Output
15	N.C.	+V Output
23	-V Input	-V Input
24	-V Input	-V Input

(The Pin Connection of high isolation one is the same with normal one.)