

VD-4W Series



4W 2:1 Regulated Single & Dual output

Features

- Wide 2:1 Input Range
- Full SMD Technology
- 1500 VDC Isolation, Up to 3500 VDC
- Continuous Short Circuit Protection
- Efficiency up to 82%
- -40 ~ 85°C Operation Temperature Range
- Metal Case Standard, Optional Plastic Case



The VD series is a family of cost effective 4.0W single & dual output DC-DC converters. These converters are consisted with Nickle-coated copper in a 24-pin DIL package with high performance features such as 1500 VDC ~ 3500VDC input/output isolation voltage, continuous short circuit protection with automatic restart and tight line / load regulation. Devices are encapsulated using flame retardant resin. Input voltages of 12,24 and 48 with output voltage of 3.3,5,9,12,15, 24, ±3.3, ±5, ±9, ±12, ±15 and ±24 Vdc. High performance features include high efficiency operation up to 75% and output voltage accuracy of ±1% maximum.

All specifications typical at Ta=25°C, nominal input voltage and full load unless otherwise specified

OUTPUT SPECIFICATIONS	
Voltage accuracy	±1%
Line regulation	±0.5%
Load regulation	±0.5%
	(Output 3.3V / ±3.3V Model) ±1.5%
Ripple & noise(20 MHz bandwidth)(1)	60mV pk-pk
Short circuit protection	Indefinite(Automatic Recovery)
Temperature coefficient	±0.02%/°C
Capacitor load(2)	See table

INPUT SPECIFICATIONS	
Voltage Range	See table
Max. Input Current	See table
No-Load Input Current	See table
Input Filter	PI Type
Input Reflected Ripple Current(3)	35mA pk-pk

GENERAL SPECIFICATIONS	
Efficiency	See table, typ.
I/O Isolation Voltage(3 sec)	
Input/Output	1500~3500Vdc
Metal Case/Input & Output	1000Vdc
I/O Isolation Capacitance	500 pF, typ.
I/O Isolation Resistance	1000M Ohm
Switching Frequency	266kHz, typ.
Humidity	95% rel H
Reliability Calculated MTBF(MIL-HDBK-217 F)	>1.121 Mhrs
Safety Standard : (designed to meet)	IEC 60950-1

PHYSICAL SPECIFICATIONS	
Case Material	Nickel-coated Copper
	Non-conductive Black Plastic(UL94V-0 rated)
Base Material	Non-conductive Black Plastic(UL94V-0 rated)
Pin Material	Ø0.5mm Brass Solder-coated
Potting Material	Epoxy (UL94V-0 rated)
Weight	17.0g(Metal Case)/13.5g(Plastic Case)
Dimensions	1.25"x0.8"x0.4"

ENVIRONMENT SPECIFICATIONS	
Operating Temperature	-40°C~85°C(See Derating Curve)
Maximum Case Temperature	100°C
Storage Temperature	-40°C~125°C
Cooling	Nature Convection

ABSOLUTE MAXIMUM RATINGS(4)	
These are stress ratings. Exposure of devices to any of these conditions may adversely affect long-term reliability.	
Input Surge Voltage(100mS)	
12 Models	24 Vdc, max.
24 Models	40 Vdc, max.
48 Models	80 Vdc, max.
Soldering Temperature (1.5mm from case 10sec. max.)	260°C, max.

EMC SPECIFICATIONS		
Radiated Emissions	EN55022	CLASS A
Conducted Emissions (5)	EN55022	CLASS A
ESD	IEC 61000-4-2	Perf. Criteria A
RS	IEC 61000-4-3	Perf. Criteria A
EFT (6)	IEC 61000-4-4	Perf. Criteria A
Surge (6)	IEC 61000-4-5	Perf. Criteria A
CS	IEC 61000-4-6	Perf. Criteria A
PFMF	IEC 61000-4-8	Perf. Criteria A

The information and specifications contained in this data sheet are believed to be correct at time of publication. However, MOTIEN Technologies accepts no responsibility for consequences arising from printing errors or inaccuracies. Specifications are subject to change without notice. No rights under any patent accompany the sale of any such product(s) or information contained herein.

VD - 4W 2:1 Regulated Single & Dual output

PART NUMBER STRUCTURE

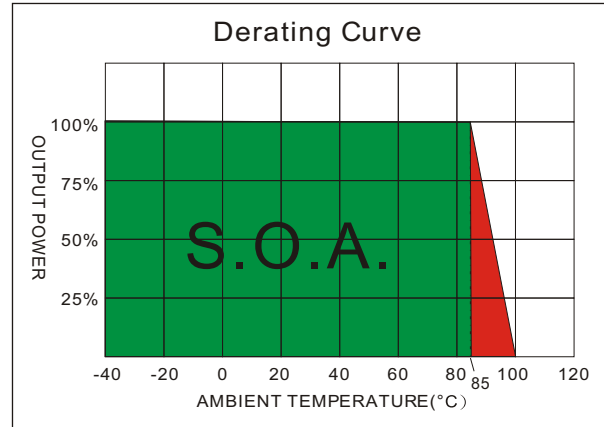
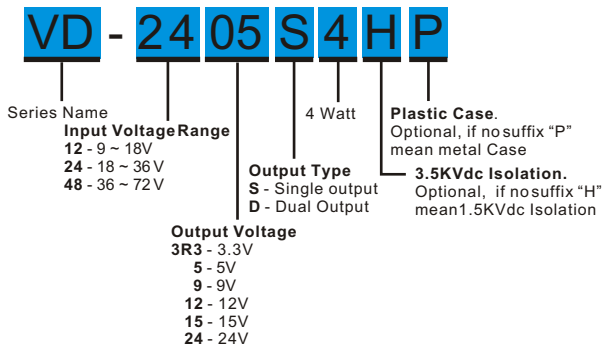

MODEL SELECTION GUIDE

MODEL NUMBER	INPUT Voltage Range (Vdc)	INPUT Current		OUTPUT Voltage (Vdc)	OUTPUT Current		EFFICIENCY @FL(%)	Capacitor Load(µF)
		No-Load (mA)	Full Load (mA)		Min. load (mA)	Full load (mA)		
VD-123R3S4	9-18	30	463	3.3	0	1200	72	3300
VD-1205S4	9-18	30	428	5	0	800	78	1000
VD-1209S4	9-18	30	428	9	0	444	78	470
VD-1212S4	9-18	30	417	12	0	333	80	220
VD-1215S4	9-18	30	417	15	0	266	80	100
VD-1224S4	9-18	30	417	24	0	166	80	47
VD-123R3D4	9-18	30	452	±3.3	0	±600	73	±680
VD-1205D4	9-18	30	428	±5	0	±400	78	±470
VD-1209D4	9-18	30	417	±9	0	±220	80	±220
VD-1212D4	9-18	30	417	±12	0	±166	80	±100
VD-1215D4	9-18	30	417	±15	0	±133	80	±47
VD-1224D4	9-18	30	421	±24	0	±83	79	±22
VD-243R3S4	18-36	20	223	3.3	0	1200	75	3300
VD-2405S4	18-36	20	209	5	0	800	80	1000
VD-2409S4	18-36	20	209	9	0	444	80	470
VD-2412S4	18-36	20	201	12	0	333	83	220
VD-2415S4	18-36	20	209	15	0	266	80	100
VD-2424S4	18-36	20	196	24	0	166	85	47
VD-243R3D4	18-36	20	226	±3.3	0	±600	73	±680
VD-2405D4	18-36	20	211	±5	0	±400	79	±470
VD-2409D4	18-36	20	209	±9	0	±220	80	±220
VD-2412D4	18-36	20	204	±12	0	±166	82	±100
VD-2415D4	18-36	20	209	±15	0	±133	80	±47
VD-2424D4	18-36	20	214	±24	0	±83	78	±22
VD-483R3S4	36-72	15	112	3.3	0	1200	75	3300
VD-4805S4	36-72	15	105	5	0	800	80	1000
VD-4809S4	36-72	15	102	9	0	444	82	470
VD-4812S4	36-72	15	105	12	0	333	80	220
VD-4815S4	36-72	15	103	15	0	266	81	100
VD-4824S4	36-72	15	102	24	0	166	82	47

Suffix "H" means 3.5KVdc isolation

Suffix "P" means Plastic case instead of standard Metal Case

VD - 4W 2:1 Regulated Single & Dual output

MODEL NUMBER	INPUT Voltage Range (Vdc)	INPUT Current		OUTPUT Voltage (Vdc)	OUTPUT Current		EFFICIENCY @FL(%)	Capacitor Load(μF)
		No-Load (mA)	Full Load (mA)		Min. load (mA)	Full load (mA)		
VD-483R3D4	36-72	15	116	±3.3	0	±600	72	±680
VD-4805D4	36-72	15	107	±5	0	±400	78	±470
VD-4809D4	36-72	15	107	±9	0	±220	78	±220
VD-4812D4	36-72	15	105	±12	0	±166	80	±100
VD-4815D4	36-72	15	105	±15	0	±133	80	±47
VD-4824D4	36-72	15	105	±24	0	±83	80	±22

Suffix "H" means 3.5KVdc isolation

Suffix "P" means Plastic case instead of standard Metal Case

NOTE

1. Ripple/Noise measured with a 1μF ceramic capacitor.
2. Test by nominal input voltage and constant resistor load.
3. Measured Input reflected ripple current with a simulated source inductance of 12μH.
4. Exceeding the absolute ratings of the unit could cause damage. It is not allowed for continuous operating.
5. Input filter components are required to help meet conducted emission class A, which application refer to the EMI Filter of design & feature configuration.
6. An external filter capacitor is required if the module has to meet IEC 61000-4-4 and IEC 61000-4-5.
The filter capacitor Motien suggest: Nippon - chemi - con KY series, 220μF/100V.

TEST CONFIGURATIONS

Input Reflected Ripple Current Test Step

Input reflected ripple current is measured through a source inductor L_{in} (12μH) and a source capacitor C_{in} (47μF, ESR<1.0Ω at 100KHz) at nominal input and full load.

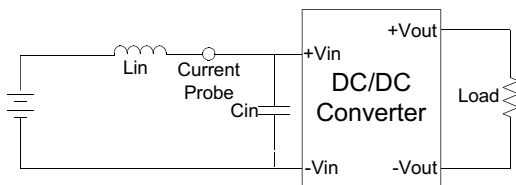

EMI Filter

Input filter components (C_1 , L) are used to help meet conducted emissions requirement for the module. These components should be mounted as close as possible to the module; and all leads should be minimized to decrease radiated noise.

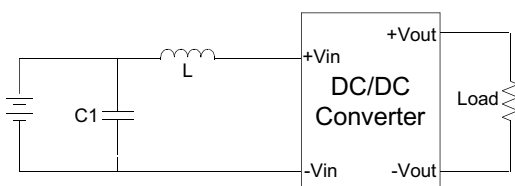

C1	L
100μF, 100V	12μH

Output Ripple & Noise Measurement Test

Use a capacitor C_{out} (1.0μF) measurement. The Scope measurement bandwidth is 0-20MHz.

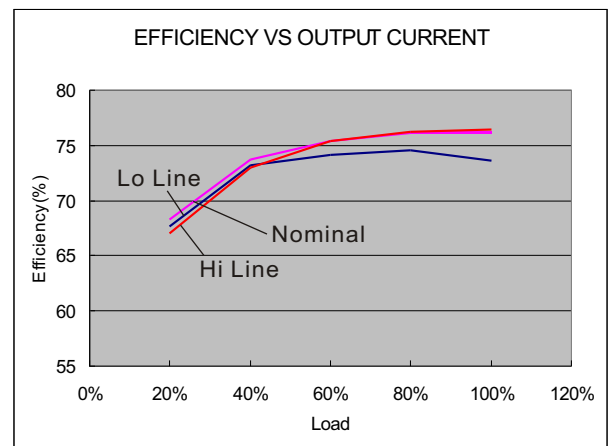
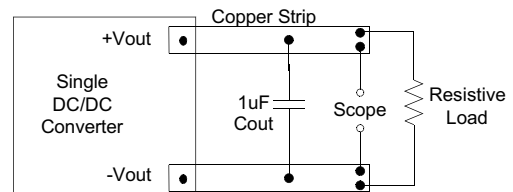

12 Models

VD - 4W 2:1 Regulated Single & Dual output

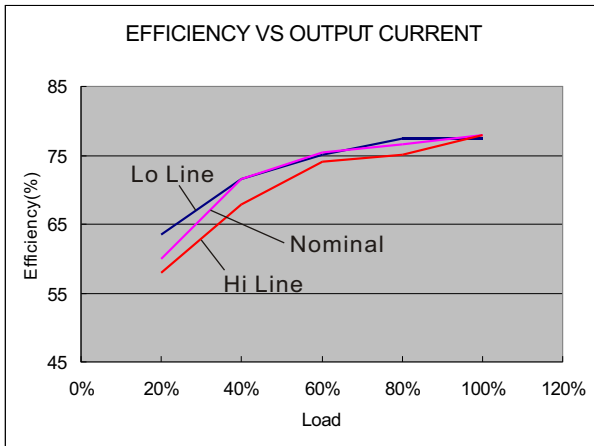

24 Models

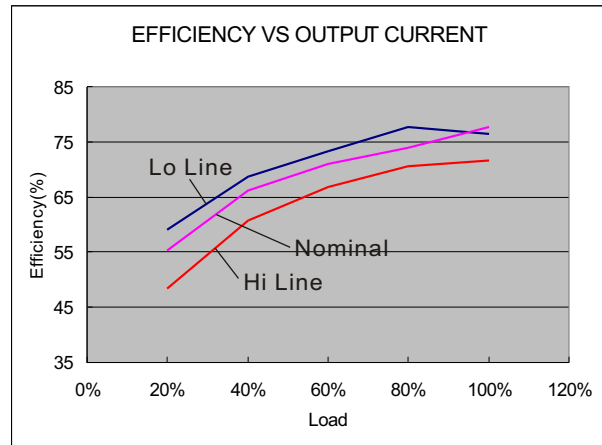

48 Models

MECHANICAL SPECIFICATIONS

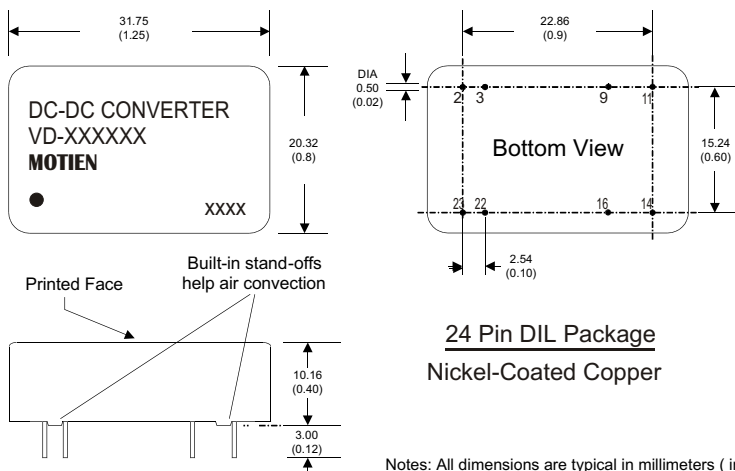

24 Pin DIL Package
Nickel-Coated Copper

- Notes: All dimensions are typical in millimeters (inches).
1. Pin diameter: 0.5 ± 0.05 (0.02 ± 0.002)
 2. Pin pitch and length tolerance: ± 0.35 (± 0.014)
 3. Case Tolerance: ± 0.5 (± 0.02)

PIN CONNECTIONS		
PIN NUMBER	SINGLE	DUAL
2	-V Input	-V Input
3	-V Input	-V Input
9	N.P.	Common
11	N.C.	-V Output
14	+V Output	+V Output
16	-V Output	Common
22	+V Input	+V Input
23	+V Input	+V Input

(The Pin Connection of high isolation one is the same with normal one.)

MECHANICAL SPECIFICATIONS

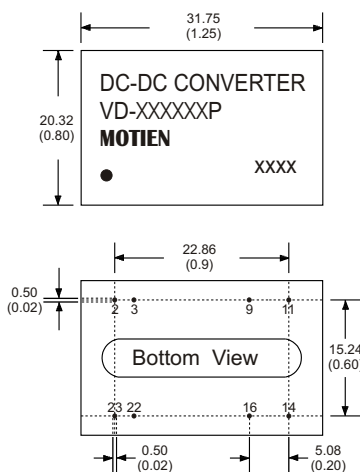

For "P" Case
24 Pin DIL Package
Non-Conductive Plastic

- Notes: All dimensions are typical in millimeters (inches).
1. Pin diameter: 0.5 ± 0.05 (0.02 ± 0.002)
 2. Pin pitch and length tolerance: ± 0.35 (± 0.014)
 3. Case Tolerance: ± 0.5 (± 0.02)

PIN CONNECTIONS		
PIN NUMBER	SINGLE	DUAL
2	-V Input	-V Input
3	-V Input	-V Input
9	N.P.	Common
11	N.C.	-V Output
14	+V Output	+V Output
16	-V Output	Common
22	+V Input	+V Input
23	+V Input	+V Input

(The Pin Connection of high isolation one is the same with normal one.)