

R6-4W Series



4W 2:1 Regulated Single & Dual output

Features

- Wide 2:1 Input Range
- Full SMD Technology
- 1500 VDC Isolation, Up to 3500 VDC
- Continuous Short Circuit Protection
- Efficiency up to 80%
- -40 ~ 85°C Operating Temperature
- Plastic Case Standard, Optional Metal Case



The R6 series is a family of cost effective 4W single & dual output DC-DC converters. These converters combine Plastic case in a 24-pin DIL package with high performance features such as 1500 VDC ~ 3500VDC input/output isolation voltage, continuous short circuit protection with automatic restart and high line / load regulation. Devices are encapsulated using flame retardant resin. Input voltages of 12, 24 and 48 with output voltage of 5, 9, 12, 15, 24, ±5, ±9, ±12, ±15 and ±24 Vdc. High performance features include high efficiency operation up to 82% and output voltage accuracy of ±1% maximum.

All specifications typical at Ta=25°C, nominal input voltage and full load unless otherwise specified

OUTPUT SPECIFICATIONS	
Voltage accuracy	±1%
Line regulation	±0.5%
Load regulation	±0.5%
Ripple & noise(20 MHz bandwidth)(1)	60mV pk-pk
Short circuit protection	Continuous
Temperature coefficient	±0.02%/°C
Capacitor load(2)	See table

INPUT SPECIFICATIONS	
Voltage Range	See table
Max. Input Current	See table
No-Load Input Current	See table
Input Filter	PI Type
Input Reflected Ripple Current(3)	35mA pk-pk

GENERAL SPECIFICATIONS	
Efficiency	See table, typ
I/O Isolation Voltage(3 sec)	
Input/Output	1500~3500Vdc
Metal Case/Input & Output	1000Vdc
I/O Isolation Capacitance	60 pF Typ.
I/O Isolation Resistance	1000M Ohm
Switching Frequency	100~400kHz
Humidity	95% rel H
Reliability Calculated MTBF(MIL-HDBK-217 F)	>1Mhrs
Safety Standard : (desinged to meet)	IEC 60950-1

ENVIRONMENT SPECIFICATIONS	
Operating Temperature	-40°C~85°C(See Derating Curve) -40°C~71°C(For 100% load)
Maximum Case Temperature	100°C
Storage Temperature	-40°C~125°C
Cooling	Nature Convection

PHYSICAL SPECIFICATIONS	
Case Material	Non-conductive Black Plastic(UL94V-0 rated) Nickel-coated Copper
Base Material	Non-conductive Black Plastic(UL94V-0 rated)
Pin Material	Ø0.5mm Brass Solder-coated
Potting Material	Epoxy (UL94V-0 rated)
Weight	12.5g(Plastic Case)/15.0g(Metal Case)
Dimensions	1.25"x0.8"x0.4"

ABSOLUTE MAXIMUM RATINGS(4)	
These are stress ratings. Exposure of devices to any of these conditions may adversely affect long-term reliability.	
Input Surge Voltage(100mS)	
12 Models	24 Vdc,max.
24 Models	40 Vdc,max.
48 Models	80 Vdc,max.
Soldering Temperature (1.5mm from case 10sec. max.)	260°C max.

EMC SPECIFICATIONS		
Radiated Emissions	EN55022	CLASS A
Conducted Emissions (7)	EN55022	CLASS A
ESD	IEC 61000-4-2	Perf. Criteria A
RS	IEC 61000-4-3	Perf. Criteria A
EFT (8)	IEC 61000-4-4	Perf. Criteria A
Surge (8)	IEC 61000-4-5	Perf. Criteria A
CS	IEC 61000-4-6	Perf. Criteria A
PFMF	IEC 61000-4-8	Perf. Criteria A

The information and specifications contained in this data sheet are believed to be correct at time of publication. However, MOTIEN Technologies accepts no responsibility for consequences arising from printing errors or inaccuracies. Specifications are subject to change without notice. No rights under any patent accompany the sale of any such product(s) or information contained herein.

R6 - 4W 2:1 Regulated Single & Dual output

PARTNUMBER STRUCTURE

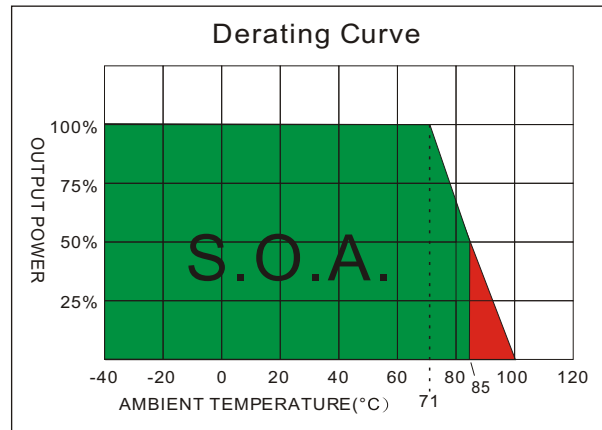
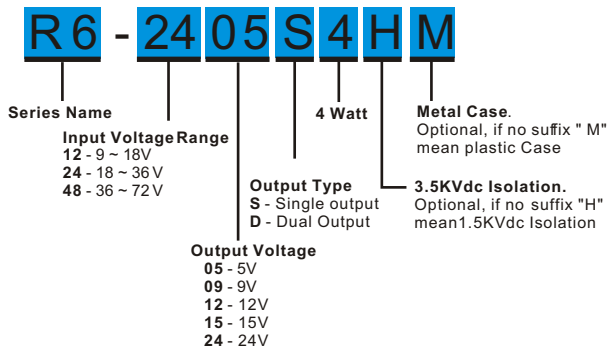

MODEL SELECTION GUIDE

MODEL NUMBER	INPUT Voltage Range (Vdc)	INPUT Current		OUTPUT Voltage (Vdc)	OUTPUT Current		EFFICIENCY @FL (%)	Capacitor Load (uF)
		No-Load (mA)	Full Load (mA)		Min. load (mA)	Full load (mA)		
R6-1205S4	9-18	20	463	5	200	800	72	2200
R6-1209S4	9-18	20	427	9	111	444	78	470
R6-1212S4	9-18	20	427	12	83.3	333	78	470
R6-1215S4	9-18	20	433	15	66.8	267	77	470
R6-1224S4	9-18	20	439	24	42	167	76	220
R6-1205D4	9-18	20	433	±5	±100	±400	77	±1000
R6-1209D4	9-18	20	433	±9	±56	±222	77	±220
R6-1212D4	9-18	20	427	±12	±42	±167	78	±220
R6-1215D4	9-18	20	427	±15	±33	±133	78	±220
R6-1224D4	9-18	20	433	±24	±21	±83	77	±100
R6-2405S4	18-36	12	216	5	200	800	77	2200
R6-2409S4	18-36	12	214	9	111	444	78	470
R6-2412S4	18-36	12	211	12	83	333	79	470
R6-2415S4	18-36	12	208	15	67	267	80	470
R6-2424S4	18-36	12	216	24	42	167	77	220
R6-2405D4	18-36	12	216	±5	±100	±400	77	±1000
R6-2409D4	18-36	12	216	±9	±56	±222	77	±220
R6-2412D4	18-36	12	214	±12	±42	±167	78	±220
R6-2415D4	18-36	12	211	±15	±33	±133	79	±220
R6-2424D4	18-36	12	219	±24	±21	±83	76	±100
R6-4805S4	36-72	8	108	5	200	800	77	2200
R6-4809S4	36-72	8	108	9	111	444	77	470
R6-4812S4	36-72	8	107	12	83	333	78	470
R6-4815S4	36-72	8	107	15	67	267	77	470
R6-4824S4	36-72	8	111	24	42	167	75	220
R6-4805D4	36-72	8	114	±5	±100	±400	73	±1000
R6-4809D4	36-72	8	108	±9	±56	±222	77	±220
R6-4812D4	36-72	8	108	±12	±42	±167	77	±220
R6-4815D4	36-72	8	107	±15	±33	±133	78	±220
R6-4824D4	36-72	8	110	±24	±21	±83	76	±100

Suffix "H" means 3.5KVdc isolation
 Suffix "M" means Metal Case instead of standard Plastic case

TEST CONFIGURATIONS

EMI Filter

Input filter components (C1,C2, L) are used to help meet conducted emissions requirement for the module. These components should be mounted as close as possible to the module; and all leads should be minimized to decrease radiated noise.

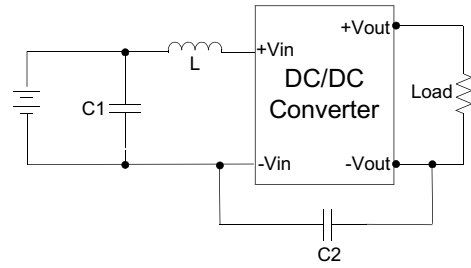

	C1	L	C2
R6-05XXXXX	220uF/100V	12uH	
R6-12XXXXX	220uF/100V	12uH	
R6-24XXXXX	220uF/100V	12uH	MLCC 471K
R6-48XXXXX	220uF/100V	12uH	MLCC 471K

NOTE

1. Typical value at nominal input voltage and full load.
2. Test by nominal input voltage and constant resistor load.
3. Measured Input reflected ripple current with a simulated source inductance of 12uH.
4. Exceeding the absolute ratings of the unit could cause damage. It is not allowed for continuous operating.
5. Operation under no-load conditions will not damage these devices, however they may not meet all listed specifications.
6. It's necessary to add minimum capacitor in output for some models, please check single model datasheet for detail value.
7. Input filter components are required to help meet conducted emission class A, which application refers to the EMI Filter of design & feature configuration.
8. An external filter capacitor is required if the module has to meet IEC61000-4-4 and IEC61000-4-5.
The filter capacitor Motien suggest: Nippon - chemi - con KY series, 220uF/100V.

MECHANICAL SPECIFICATIONS FOR HIGH ISOLATION MODEL

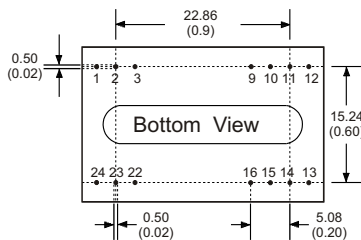
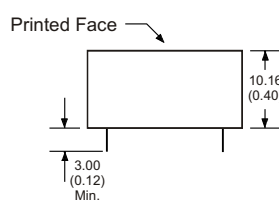
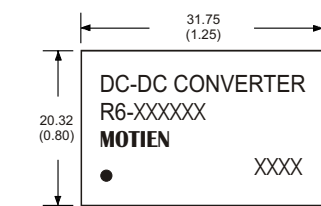

24 Pin DIL Package
Non-Conductive Plastic

- Notes: All dimensions are typical in millimeters (inches).
1. Pin diameter: 0.5 ±0.05 (0.02 ±0.002)
 2. Pin pitch and length tolerance: ±0.35 (±0.014)
 3. Case Tolerance: ±0.5 (±0.02)

PIN CONNECTIONS

PIN NUMBER	SINGLE	DUAL	SINGLE-H	DUAL-H
1	+V Input	+V Input	N.P.	N.P.
2	N.C.	-V Output	-V Input	-V Input
3	N.C.	Common	-V Input	-V Input
9	N.P.	N.P.	N.P.	Common
10	-V Output	Common	N.P.	N.P.
11	+V Output	+V Output	N.C.	-V Output
12	-V Input	-V Input	N.P.	N.P.
13	-V Input	-V Input	N.P.	N.P.
14	+V Output	+V Output	+V Output	+V Output
15	-V Output	Common	N.P.	N.P.
16	N.P.	N.P.	-V Output	Common
22	N.C.	Common	+V Input	+V Input
23	N.C.	-V Output	+V Input	+V Input
24	+V Input	+V Input	N.P.	N.P.

MECHANICAL SPECIFICATIONS

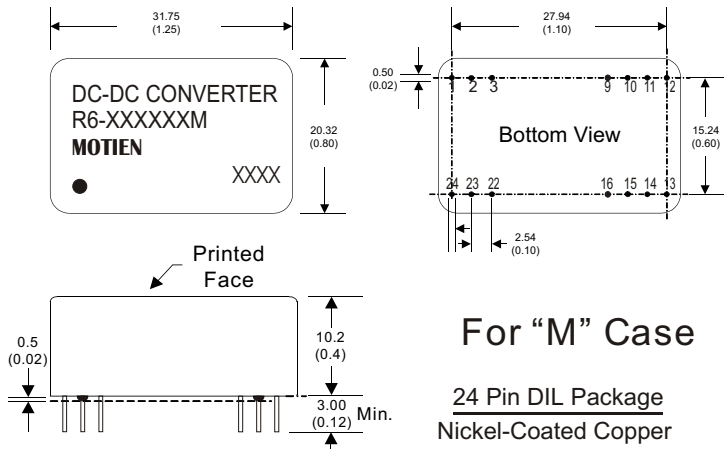

For "M" Case

24 Pin DIL Package
Nickel-Coated Copper

- Notes: All dimensions are typical in millimeters (inches).
1. Pin diameter: 0.5 ± 0.05 (0.02 ± 0.002)
 2. Pin pitch and length tolerance: ± 0.35 (± 0.014)
 3. Case Tolerance: ± 0.5 (± 0.02)
 4. Stand-off tolerance: ± 0.1 (± 0.004)

PIN CONNECTIONS				
PIN NUMBER	SINGLE	DUAL	SINGLE-H	DUAL-H
1	+V Input	+V Input	N.P.	N.P.
2	N.C.	-V Output	-V Input	-V Input
3	N.C.	Common	-V Input	-V Input
9	N.P.	N.P.	N.P.	Common
10	-V Output	Common	N.P.	N.P.
11	+V Output	+V Output	N.C.	-V Output
12	-V Input	-V Input	N.P.	N.P.
13	-V Input	-V Input	N.P.	N.P.
14	+V Output	+V Output	+V Output	+V Output
15	-V Output	Common	N.P.	N.P.
16	N.P.	N.P.	-V Output	Common
22	N.C.	Common	+V Input	+V Input
23	N.C.	-V Output	+V Input	+V Input
24	+V Input	+V Input	N.P.	N.P.