

RP-5W Series



5W 4:1 Regulated Single & Dual output

Features

- Wide 4:1 Input Range
- Full SMD Technology
- 1500 VDC Isolation, Up to 3500 VDC
- Continuous Short Circuit Protection
- Efficiency up to 82%
- -40 ~ 85°C Operating Temperature
- Plastic Case Standard, Optional Metal Case



The RP series is a family of cost effective 5W single & dual output DC-DC converters. These converters combine Plastic case in a 24-pin DIL package with high performance features such as 1500 VDC ~ 3500VDC input/output isolation voltage, continuous short circuit protection with automatic restart and high line / load regulation. Devices are encapsulated using flame retardant resin. Input voltages of 24 and 48 with output voltage of 3.3, 5, 12, 15, ± 5 , ± 12 and ± 15 Vdc. High performance features include high efficiency operation up to 82% and output voltage accuracy of $\pm 1\%$ maximum.

All specifications typical at Ta=25°C, nominal input voltage and full load unless otherwise specified

OUTPUT SPECIFICATIONS	
Voltage accuracy	$\pm 1\%$
Line regulation	$\pm 0.5\%$
Load regulation	$\pm 0.5\%$
Ripple & noise(20 MHz bandwidth)(1)	60mV pk-pk
Short circuit protection	Continuous
Temperature coefficient	$\pm 0.02\%/^{\circ}\text{C}$
Capacitor load(2)	See table

INPUT SPECIFICATIONS	
Voltage Range	See table
Max. Input Current	See table
No-Load Input Current	See table
Input Filter	PI Type
Input Reflected Ripple Current(3)	35mA pk-pk

GENERAL SPECIFICATIONS	
Efficiency	See table, typ.
I/O Isolation Voltage(3 sec)	
Input/Output	1500~3500Vdc
Metal Case/Input & Output	1000Vdc
I/O Isolation Capacitance	500 pF typ.
I/O Isolation Resistance	1000M Ohm
Switching Frequency	100~400kHz
Humidity	95% rel H
Reliability Calculated MTBF(MIL-HDBK-217 F)	>1Mhrs
Safety Standard : (designed to meet)	IEC 60950-1

PHYSICAL SPECIFICATIONS	
Case Material	Non-conductive Black Plastic(UL94V-0 rated) Nickel-coated Copper
Base Material	Non-conductive Black Plastic(UL94V-0 rated)
Pin Material	$\varnothing 0.5\text{mm}$ Brass Solder-coated
Potting Material	Epoxy (UL94V-0 rated)
Weight	12.5g(Plastic Case)/15.0g(Metal Case)
Dimensions	1.25"x0.8"x0.4"

ENVIRONMENT SPECIFICATIONS	
Operating Temperature	-40°C~85°C(See Derating Curve) -40°C~71°C(For 100% load)
Maximum Case Temperature	100°C
Storage Temperature	-40°C~125°C
Cooling	Nature Convection

ABSOLUTE MAXIMUM RATINGS(4)	
These are stress ratings. Exposure of devices to any of these conditions may adversely affect long-term reliability.	
Input Surge Voltage(100mS)	
24 Models	40 Vdc, max.
48 Models	80 Vdc, max.
Soldering Temperature (1.5mm from case 10sec. max.)	260°C max.

The information and specifications contained in this data sheet are believed to be correct at time of publication. However, MOTIEN Technologies accepts no responsibility for consequences arising from printing errors or inaccuracies. Specifications are subject to change without notice. No rights under any patent accompany the sale of any such product(s) or information contained herein.

RP - 5W 4:1 Regulated Single & Dual output

PART NUMBER STRUCTURE

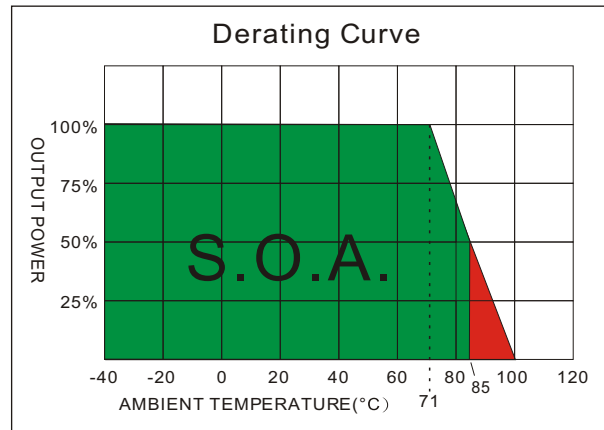
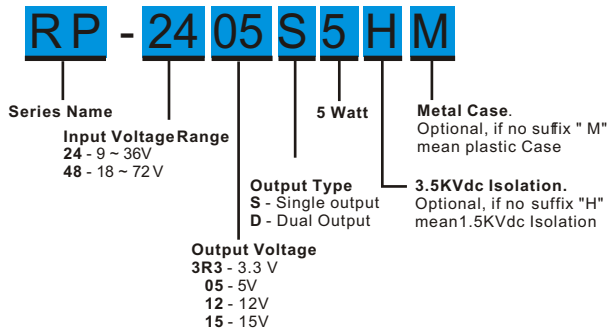

MODEL SELECTION GUIDE

MODEL NUMBER	INPUT Voltage Range (Vdc)	INPUT Current		OUTPUT Voltage (Vdc)	OUTPUT Current		EFFICIENCY @FL (%)	Capacitor Load (uF)
		No-Load (mA)	Full Load (mA)		Min. load (mA)	Full load (mA)		
RP-243R 3S5	9-36	20	243	3.3	300	1200	68	2200
RP-2405 S5	9-36	20	285	5	250	1000	73	1000
RP-2412 S5	9-36	20	282	12	105	416	74	470
RP-2415 S5	9-36	20	282	15	84	333	74	470
RP-2405 D5	9-36	20	271	±5	±125	±500	77	±1000
RP-2412 D5	9-36	20	254	±12	±53	±208	82	±220
RP-2415 D5	9-36	20	254	±15	±42	±166	82	±220
RP-483R 3S5	18-72	15	118	3.3	300	1200	70	2200
RP-4805 S5	18-72	15	143	5	250	1000	73	1000
RP-4812 S5	18-72	15	141	12	105	416	74	470
RP-4815 S5	18-72	15	137	15	84	333	76	470
RP-4805 D5	18-72	15	145	±5	±125	±500	72	±1000
RP-4812 D5	18-72	15	139	±12	±53	±208	75	±220
RP-4815 D5	18-72	15	139	±15	±42	±166	75	±220

Suffix "H" means 3.5KVdc isolation
 Suffix "M" means Metal Case instead of standard Plastic case

NOTE

1. Typical value at nominal input voltage and full load.
2. Test by nominal input voltage and constant resistor load.
3. Measured Input reflected ripple current with a simulated source inductance of 12uH.
4. Exceeding the absolute ratings of the unit could cause damage. It is not allowed for continuous operating.
5. Operation under no-load conditions will not damage these devices, however they may not meet all listed specifications.
6. It's necessary to add minimum capacitor in output for some models, please check single model datasheet for detail value.

RP - 5W 4:1 Regulated Single & Dual output

MECHANICAL SPECIFICATIONS FOR HIGH ISOLATION MODEL

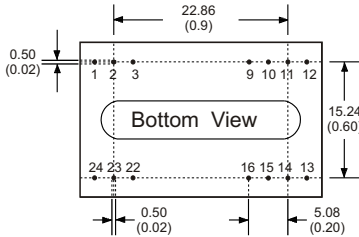
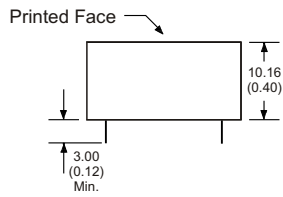
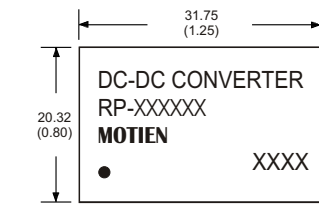

24 Pin DIL Package
Non-Conductive Plastic

Notes: All dimensions are typical in millimeters (inches).
 1. Pin diameter: 0.5 ± 0.05 (0.02 ± 0.002)
 2. Pin pitch and length tolerance: ± 0.35 (± 0.014)
 3. Case Tolerance: ± 0.5 (± 0.02)

PIN CONNECTIONS				
PIN NUMBER	SINGLE	DUAL	SINGLE-H	DUAL-H
1	+V Input	+V Input	N.P.	N.P.
2	N.C.	-V Output	-V Input	-V Input
3	N.C.	Common	-V Input	-V Input
9	N.P.	N.P.	N.P.	Common
10	-V Output	Common	N.P.	N.P.
11	+V Output	+V Output	N.C.	-V Output
12	-V Input	-V Input	N.P.	N.P.
13	-V Input	-V Input	N.P.	N.P.
14	+V Output	+V Output	+V Output	+V Output
15	-V Output	Common	N.P.	N.P.
16	N.P.	N.P.	-V Output	Common
22	N.C.	Common	+V Input	+V Input
23	N.C.	-V Output	+V Input	+V Input
24	+V Input	+V Input	N.P.	N.P.

MECHANICAL SPECIFICATIONS

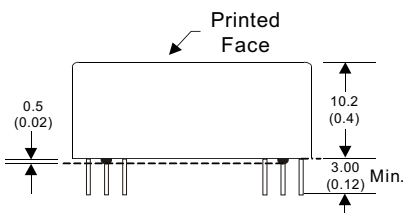
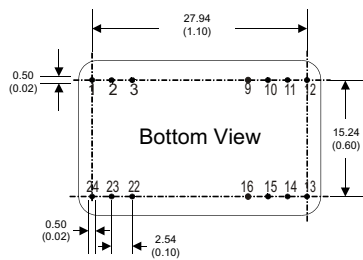
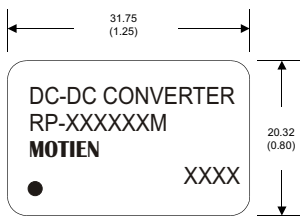

For "M" Case
24 Pin DIL Package
Nickel-Coated Copper

Notes: All dimensions are typical in millimeters (inches).
 1. Pin diameter: 0.5 ± 0.05 (0.02 ± 0.002)
 2. Pin pitch and length tolerance: ± 0.35 (± 0.014)
 3. Case Tolerance: ± 0.5 (± 0.02)
 4. Stand-off tolerance: ± 0.1 (± 0.004)

PIN CONNECTIONS				
PIN NUMBER	SINGLE	DUAL	SINGLE-H	DUAL-H
1	+V Input	+V Input	N.P.	N.P.
2	N.C.	-V Output	-V Input	-V Input
3	N.C.	Common	-V Input	-V Input
9	N.P.	N.P.	N.P.	Common
10	-V Output	Common	N.P.	N.P.
11	+V Output	+V Output	N.C.	-V Output
12	-V Input	-V Input	N.P.	N.P.
13	-V Input	-V Input	N.P.	N.P.
14	+V Output	+V Output	+V Output	+V Output
15	-V Output	Common	N.P.	N.P.
16	N.P.	N.P.	-V Output	Common
22	N.C.	Common	+V Input	+V Input
23	N.C.	-V Output	+V Input	+V Input
24	+V Input	+V Input	N.P.	N.P.