

VK-6W Series



6W 4:1 Regulated Single & Dual output

Features

- Wide 4:1 Input Range
- Full SMD Technology
- 1500 VDC Isolation, Up to 3500 VDC
- Continuous Short Circuit Protection
- Efficiency up to 84%
- -40 ~ 85°C Operation Temperature Range
- Metal Case Standard, Optional Plastic Case
- EMI Complies With EN55022 Class A



The VK series is a family of cost effective 6.0W single & dual output DC-DC converters. These converters are consisted with Nickel-coated copper in a 24-pin DIL package with high performance features such as 1500 VDC ~ 3500VDC input/output isolation voltage, continuous short circuit protection with automatic restart and tight line / load regulation. Devices are encapsulated using flame retardant resin. Input voltages of 24 and 48 with output voltage of 3.3, 5, 7.2, 9, 12, 15, 18, 24, ± 3.3 , ± 5 , ± 7.2 , ± 9 , ± 12 , ± 15 , ± 18 and ± 24 Vdc. High performance features include high efficiency operation up to 84% and output voltage accuracy of $\pm 1\%$ maximum.

All specifications typical at $T_a=25^\circ\text{C}$, nominal input voltage and full load unless otherwise specified

OUTPUT SPECIFICATIONS	
Voltage accuracy	$\pm 1\%$
Line regulation	$\pm 0.5\%$
Load regulation	$\pm 0.5\%$
	(Output 3.3V / ± 3.3 V Model) $\pm 1.5\%$
Ripple & noise(20 MHz bandwidth)(1)	60mV pk-pk
Short circuit protection	Indefinite(Automatic Recovery)
Temperature coefficient	$\pm 0.02\%/^\circ\text{C}$
Capacitor load(2)	See table

INPUT SPECIFICATIONS	
Voltage Range	See table
Max. Input Current	See table
No-Load Input Current	See table
Input Filter	PI Type
Input Reflected Ripple Current(3)	35mA pk-pk

GENERAL SPECIFICATIONS	
Efficiency	See table, typ
I/O Isolation Voltage(3 sec)	
Input/Output	1500~3500Vdc
Metal Case/Input & Output	1000Vdc
I/O Isolation Capacitance	500 pF Typ.
I/O Isolation Resistance	1000M Ohm
Switching Frequency	Typical 266kHz
Humidity	95% rel H
Reliability Calculated MTBF(MIL-HDBK-217 F)	>1.121 Mhrs
Safety Standard : (designed to meet)	IEC 60950-1

EMC SPECIFICATIONS		
Radiated Emissions	EN55022	CLASS A
Conducted Emissions (4)	EN55022	CLASS A
ESD	IEC 61000-4-2	Perf. Criteria A
RS	IEC 61000-4-3	Perf. Criteria A
EFT	IEC 61000-4-4	Perf. Criteria A
Surge (5)	IEC 61000-4-5	Perf. Criteria A
CS	IEC 61000-4-6	Perf. Criteria A
PFMF	IEC 61000-4-8	Perf. Criteria A

PHYSICAL SPECIFICATIONS	
Case Material	Nickel-coated Copper
	Non-conductive Black Plastic(UL94V-0 rated)
Base Material	Non-conductive Black Plastic(UL94V-0 rated)
Pin Material	$\varnothing 0.5\text{mm}$ Brass Solder-coated
Potting Material	Epoxy (UL94V-0 rated)
Weight	17.0g(Metal Case)/13.5g(Plastic Case)
Dimensions	1.25"x0.8"x0.4"

ENVIRONMENT SPECIFICATIONS	
Operating Temperature	$-40^\circ\text{C} \sim 85^\circ\text{C}$ (See Derating Curve)
Maximum Case Temperature	100°C
Storage Temperature	$-40^\circ\text{C} \sim 125^\circ\text{C}$
Cooling	Nature Convection

ABSOLUTE MAXIMUM RATINGS(6)	
These are stress ratings. Exposure of devices to any of these conditions may adversely affect long-term reliability.	
Input Surge Voltage(100mS)	
24 Models	40 Vdc max.
48 Models	80 Vdc max.
Soldering Temperature	260°C ,max.
(1.5mm from case 10sec. max.)	

The information and specifications contained in this data sheet are believed to be correct at time of publication. However, MOTIEN Technologies accepts no responsibility for consequences arising from printing errors or inaccuracies. Specifications are subject to change without notice. No rights under any patent accompany the sale of any such product(s) or information contained herein.

VK - 6W 4:1 Regulated Single & Dual output

PART NUMBER STRUCTURE

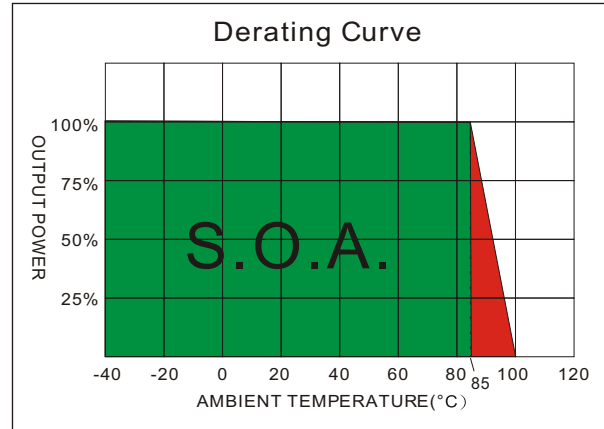
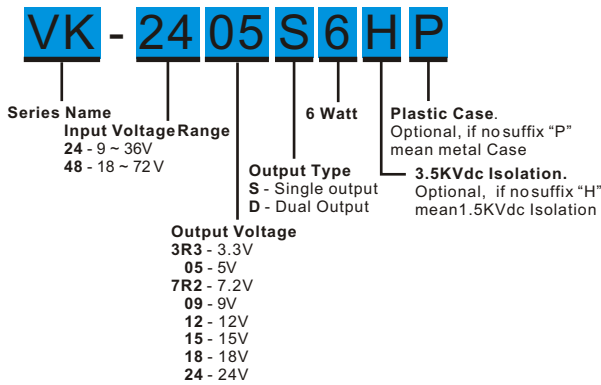

MODEL SELECTION GUIDE

MODEL NUMBER	INPUT Voltage Range (Vdc)	INPUT Current		OUTPUT Voltage (Vdc)	OUTPUT Current		EFFICIENCY @FL(%)	Capacitor Load(µF)
		No-Load (mA)	Full Load (mA)		Min. load (mA)	Full load (mA)		
VK-243R3S6	9-36	12	253.3	3.3	0	1400	76	1000
VK-2405S6	9-36	10	312.5	5	0	1200	80	1000
VK-247R2S6	9-36	18	312.5	7.2	0	833	80	470
VK-2409S6	9-36	12	301.2	9	0	666	83	220
VK-2412S6	9-36	15	301.2	12	0	500	83	1000
VK-2415S6	9-36	18	301.2	15	0	400	83	470
VK-2418S6	9-36	15	301.2	18	0	333	83	47
VK-2424S6	9-36	18	304.9	24	0	250	82	47
VK-243R3D6	9-36	12	337.8	±3.3	0	±909	74	±470
VK-2405D6	9-36	10	312.5	±5	0	±600	80	±680
VK-247R2D6	9-36	18	312.5	±7.2	0	±416	80	±220
VK-2409D6	9-36	18	308.64	±9	0	±333	81	±100
VK-2412D6	9-36	20	301.2	±12	0	±250	83	±330
VK-2415D6	9-36	22	304.9	±15	0	±200	82	±100
VK-2418D6	9-36	18	304.9	±18	0	±166	82	±10
VK-2424D6	9-36	18	312.5	±24	0	±125	80	±22
VK-483R3S6	18-72	15	126.4	3.3	0	1400	76	1000
VK-4805S6	18-72	8	156.25	5	0	1200	80	1000
VK-487R2S6	18-72	15	156.25	7.2	0	833	80	470
VK-4809S6	18-72	10	152.43	9	0	666	82	220
VK-4812S6	18-72	10	150.6	12	0	500	83	1000
VK-4815S6	18-72	10	148.8	15	0	400	84	100
VK-4818S6	18-72	10	150.6	18	0	333	83	10
VK-4824S6	18-72	12	150.6	24	0	250	83	22
VK-483R3D6	18-72	10	162.3	±3.3	0	±909	77	±330
VK-4805D6	18-72	10	158.22	±5	0	±600	79	±470
VK-487R2D6	18-72	15	156.25	±7.2	0	±416	80	±220
VK-4809D6	18-72	15	154.32	±9	0	±333	81	±100
VK-4812D6	18-72	10	152.4	±12	0	±250	82	±100
VK-4815D6	18-72	15	148.8	±15	0	±200	84	±47
VK-4818D6	18-72	15	156.25	±18	0	±166	80	±22
VK-4824D6	18-72	15	154.3	±24	0	±125	81	±22

Suffix "H" means 3.5KVdc isolation

Suffix "P" means Plastic case instead of standard Metal Case

NOTE

1. Ripple/Noise measured with a 1uF ceramic capacitor.
2. Test by nominal input voltage and constant resistor load.
3. Measured Input reflected ripple current with a simulated source inductance of 12uH.
4. It's recommended to add (C1, C2, L) in input end to achieve EN55022 conducted Class A.
5. An external filter capacitor is required if the module has to meet IEC61000-4-5.
The filter capacitor Motien suggest: Nippon - chemi - con KY series, 220uF/100V.
6. Exceeding the absolute ratings of the unit could cause damage. It is not allowed for continuous operating.

TEST CONFIGURATIONS

Output Ripple & Noise Measurement Test

Use a capacitor Cout(1.0uF) measurement.
The Scope measurement bandwidth is 0-20MHz.

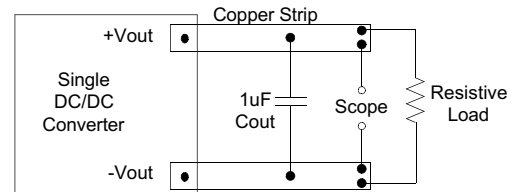

Input Reflected Ripple Current Test Step

Input reflected ripple current is measured through a source inductor Lin(12uH) and a source capacitor Cin(47uF, ESR<1.0Ω at 100KHz) at nominal input and full load.

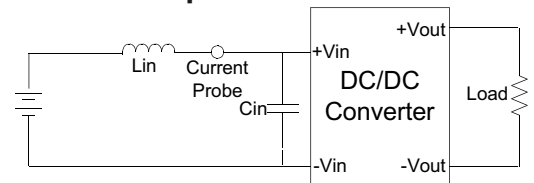

EMI Filter

Input filter components (C1,C2, L) are used to help meet conducted emissions requirement for the module. These components should be mounted as close as possible to the module; and all leads should be minimized to decrease radiated noise.

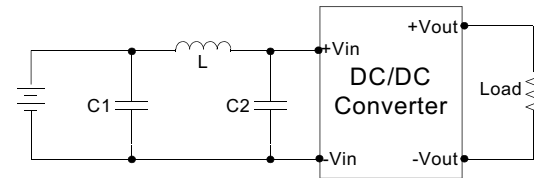

C1	L	C2
68uF, 100V	12uH	33uF, 100V

ELECTRICAL CHARACTERISTIC CURVES

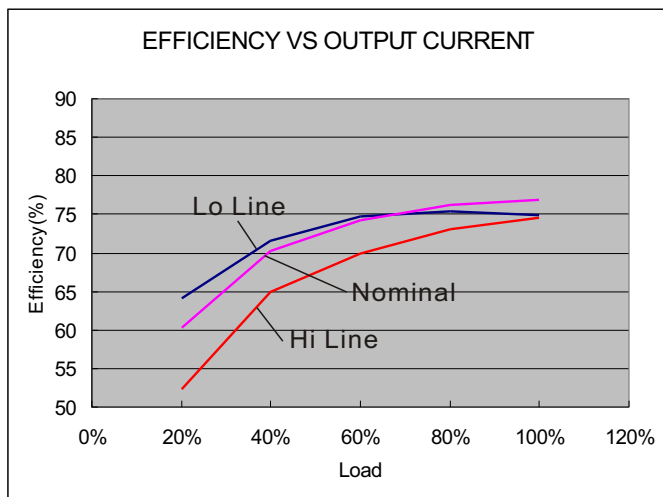

24 Models

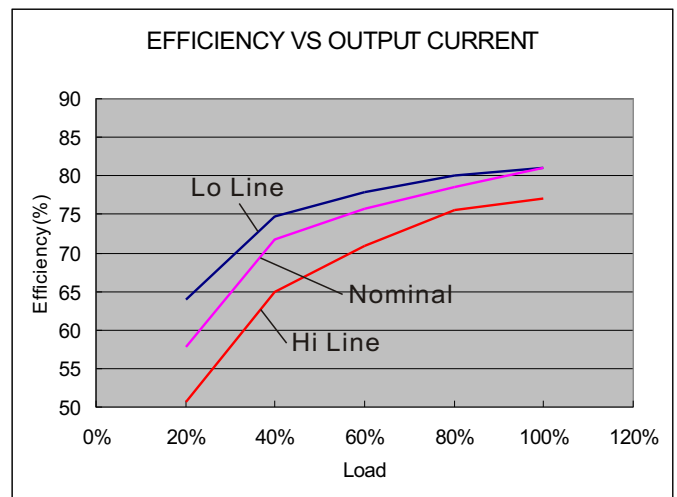

48 Models

The models listed above is just for standard type. If you need the special specification product, please contact our service member by telephone presented in shortform cover or e-mail to : sales@motien.com.tw

MECHANICAL SPECIFICATIONS

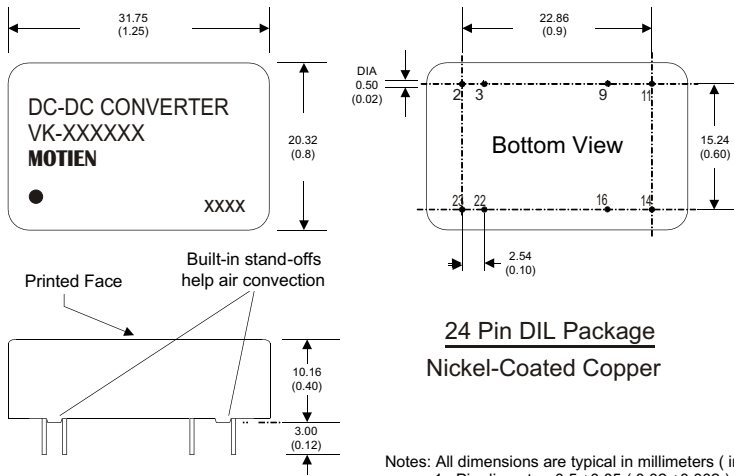

**24 Pin DIL Package
Nickel-Coated Copper**

Notes: All dimensions are typical in millimeters (inches).
 1. Pin diameter: 0.5 ± 0.05 (0.02 ± 0.002)
 2. Pin pitch and length tolerance: ± 0.35 (± 0.014)
 3. Case Tolerance: ± 0.5 (± 0.02)

PIN CONNECTIONS		
PIN NUMBER	SINGLE	DUAL
2	-V Input	-V Input
3	-V Input	-V Input
9	N.P.	Common
11	N.C.	-V Output
14	+V Output	+V Output
16	-V Output	Common
22	+V Input	+V Input
23	+V Input	+V Input

(The Pin Connection of high isolation one is the same with normal one.)

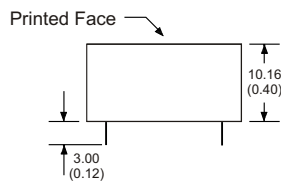
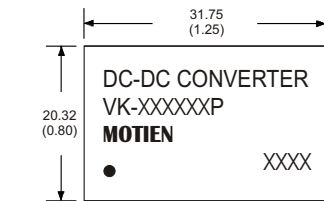

For "P" Case

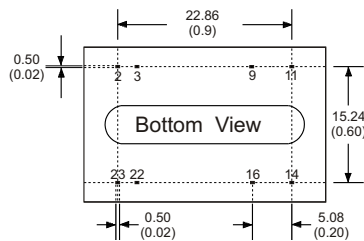

**24 Pin DIL Package
Non-Conductive Plastic**

Notes: All dimensions are typical in millimeters (inches).
 1. Pin diameter: 0.5 ± 0.05 (0.02 ± 0.002)
 2. Pin pitch and length tolerance: ± 0.35 (± 0.014)
 3. Case Tolerance: ± 0.5 (± 0.02)

PIN CONNECTIONS		
PIN NUMBER	SINGLE	DUAL
2	-V Input	-V Input
3	-V Input	-V Input
9	N.P.	Common
11	N.C.	-V Output
14	+V Output	+V Output
16	-V Output	Common
22	+V Input	+V Input
23	+V Input	+V Input

(The Pin Connection of high isolation one is the same with normal one.)