

V7W - 10W Series



10W 4:1 Regulated Single & Dual output

Features

- Wide 4:1 Input Range
- Full SMD Technology
- 1500 VDC Isolation
- Continuous Short Circuit Protection
- Efficiency up to 85%
- -40 ~ 85°C Operation Temperature Range
- Remote on/off Control (Optional)
- EMI Complies With EN55022 Class A

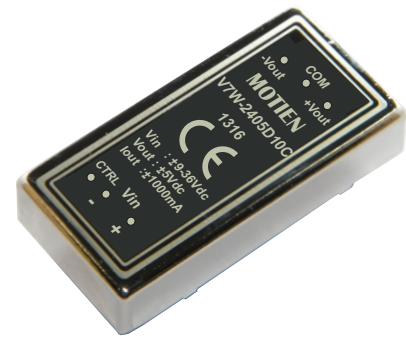

The V7W series is a family of cost effective 10W single & dual output DC-DC converters. These converters are made with nickle-coated brass case in a 2"x1" with high performance features such as 1500 VDC input/output isolation voltage, continuous short circuit protection with automatic restart and tight line / load regulation. Devices are encapsulated by using flame retardant resin. Input voltages of 24 and 48 with output voltage of 3.3, 5, 7, 2, 9, 12, 15, ±5, ±7.2, ±9, ±12, ±15 Vdc. High performance features include high efficiency operation up to 85% and output voltage accuracy of ±1% maximum.

All specifications typical at Ta=25°C, nominal input voltage and full load unless otherwise specified

OUTPUT SPECIFICATIONS	
Voltage accuracy	±1%
Line regulation	±0.5%
Load regulation	±0.5%(10% to 100% Loading) ±1%(below 10% load)
Cross Regulation (Dual Output) (1)	±5%
Ripple & noise (20 MHz bandwidth)(2)	75mV pk-pk
Over-current protection	140% of max. Iout
Short circuit protection	Indefinite(Automatic Recovery)
Temperature coefficient	±0.02%/°C
Capacitor load(3)	See table

INPUT SPECIFICATIONS	
Input Voltage Range	See table
Under Voltage Lockout	
24V Models Module ON / OFF	8.6Vdc / 8Vdc, typ.
48V Models Module ON / OFF	16Vdc / 14Vdc, typ.
Start up Time (Nominal Vin and constant resistive load)	20mS, typ.
Input Filter	Pi Type
Input Current(No-Load)	See table, typ.
Input Current(Full-Load)	See table, max.
Input Reflected Ripple Current(4)	35mA _{p-p} , typ.
CTRL(5) Module ON	2.5 to 5.5 Vdc or Open
Module OFF	-0.7 to 0.8Vdc or Short circuit pin 2 and pin 6
CTRL OFF Input Current	2.5mA, typ.

GENERAL SPECIFICATIONS	
Efficiency	See table, typ.
I/O Isolation Voltage(60 sec)	
Input/Output	1500Vdc
Case/Input & Output	1000Vdc
Isolation Resistance	1000 MΩ, min.
Isolation Capacitance	1200 pF, typ.
Switching frequency	300kHz, typ.
Humidity	95% rel H
Reliability Calculated MTBF(MIL-HDBK-217 F)	>1.121 Mhrs
Safety Standard (designed to meet)	IEC/EN 60950-1

EMC SPECIFICATIONS		
Radiated Emissions	EN55022	CLASS A
Conducted Emissions (6)	EN55022	CLASS A
ESD	IEC 61000-4-2	Perf. Criteria B
RS	IEC 61000-4-3	Perf. Criteria A
EFT	IEC 61000-4-4	Perf. Criteria A
Surge(7)	IEC 61000-4-5	Perf. Criteria A
CS	IEC 61000-4-6	Perf. Criteria A
PFMF	IEC 61000-4-8	Perf. Criteria A

PHYSICAL SPECIFICATIONS	
Case Material	Nickel-coated Brass
Pin Material	Φ1.0mm Brass Solder-coated
Potting Material	Epoxy (UL94V-0 rated)
Weight	30.0g
Dimensions	2.00"x1.00"x0.40"

ENVIRONMENT SPECIFICATIONS	
Operating Temperature	-40°C~85°C(See Derating Curve)
Maximum Case Temperature	100°C
Storage Temperature	-40°C~125°C
Cooling	Nature Convection

ABSOLUTE MAXIMUM RATINGS(8)	
These are stress ratings. Exposure of devices to any of these conditions may adversely affect long-term reliability.	
Input Surge Voltage(100mS)	
24 Models	50 Vdc max.
48 Models	100 Vdc max.
Lead Soldering Temperature (1.5mm from case 10 sec.max.)	260°C

The information and specifications contained in this data sheet are believed to be correct at time of publication. However, MOTIEN Technologies accepts no responsibility for consequences arising from printing errors or inaccuracies. Specifications are subject to change without notice. No rights under any patent accompany the sale of any such product(s) or information contained herein.

V7W - 10W 4:1 Regulated Single & Dual output

PART NUMBER STRUCTURE

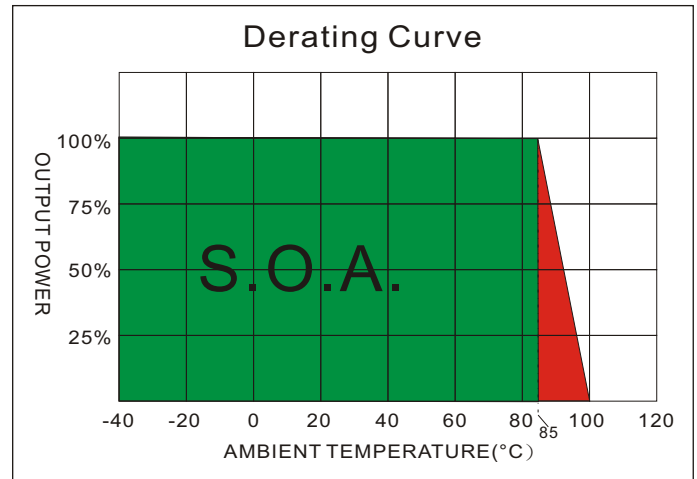
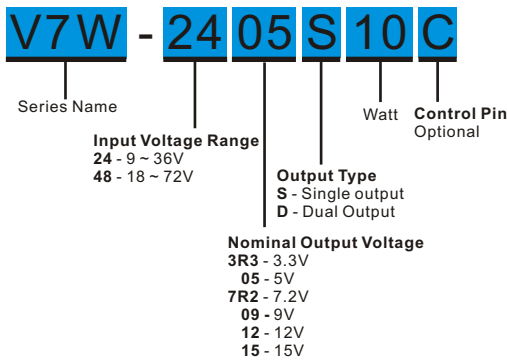

MODEL SELECTION GUIDE

MODEL NUMBER	INPUT Voltage Range (Vdc)	INPUT Current		OUTPUT Voltage (Vdc)	OUTPUT Current		EFFICIENCY @FL(%)	Capacitor Load(uF)
		No-Load (mA)	Full Load (mA)		Min. load (mA)	Full load (mA)		
V7W-243R3S10	9-36	25	348	3.3	0	2000	80	3300
V7W-2405S10	9-36	25	508	5	0	2000	82	3300
V7W-247R2S10	9-36	25	502	7.2	0	1388	83	1000
V7W-2409S10	9-36	25	502	9	0	1111	83	680
V7W-2412S10	9-36	25	490	12	0	833	85	680
V7W-2415S10	9-36	25	490	15	0	666	85	470
V7W-2405D10	9-36	25	508	±5	0	±1000	82	±2200
V7W-247R2D10	9-36	25	502	±7.2	0	±694	83	±470
V7W-2409D10	9-36	25	502	±9	0	±555	83	±470
V7W-2412D10	9-36	25	490	±12	0	±416	85	±470
V7W-2415D10	9-36	25	490	±15	0	±333	85	±330
V7W-483R3S10	18-72	20	174	3.3	0	2000	79	3300
V7W-4805S10	18-72	20	254	5	0	2000	82	3300
V7W-487R2S10	18-72	20	251	7.2	0	1388	83	1000
V7W-4809S10	18-72	20	251	9	0	1111	83	680
V7W-4812S10	18-72	20	245	12	0	833	85	680
V7W-4815S10	18-72	20	245	15	0	666	85	470
V7W-4805D10	18-72	20	254	±5	0	±1000	82	±2200
V7W-487R2D10	18-72	20	251	±7.2	0	±694	83	±470
V7W-4809D10	18-72	20	251	±9	0	±555	83	±470
V7W-4812D10	18-72	20	245	±12	0	±416	85	±470
V7W-4815D10	18-72	20	245	±15	0	±333	85	±330

NOTE

- One load is 25% to 100% load, the other load is 100% load, the output voltage variable rate is within ±5%.
- Measured with 20MHz bandwidth and 1.0uF ceramic capacitor.
- Tested by minimal Vin and constant resistive load.
- Measured Input reflected ripple current with a simulated source inductance of 12uH.
- To order the converter with CTRL function, please add suffix C (e.g. V7W-4812S10C).
- Input filter components (C1, L, C2) are used to help meet conducted emissions requirement for the module. These components should be mounted as close as possible to the module; and all leads should be minimized to decrease radiated noise.
- An external filter capacitor is required if the module has to meet IEC61000-4-4 and IEC61000-4-5.
The filter capacitor Motien suggest: Nippon chemi-con KY series, 220uF/100V.
- Exceeding the absolute ratings of the unit could cause damage. It is not allowed for continuous operating.

TEST CONFIGURATIONS

Input Reflected Ripple Current Test Step

Input reflected ripple current is measured through a source inductor L_{in} (12 μ H) and a source capacitor C_{in} (47 μ F, ESR<1.0 Ω at 100KHz) at nominal input and full load.

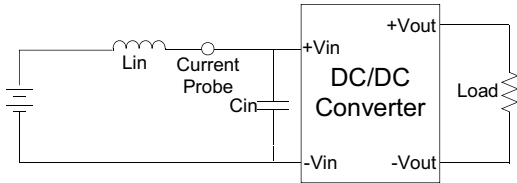

EMI Filter

Input filter components (C_1, L, C_2) are used to help meet conducted emissions requirement for the module. These components should be mounted as close as possible to the module; and all leads should be minimized to decrease radiated noise.

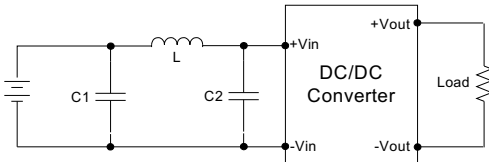

	C1	L	C2
V7W-24XXXXXX	330 μ F/100V	12 μ H	100 μ F/100V
V7W-48XXXXXX	330 μ F/100V	12 μ H	100 μ F/100V

Output Ripple & Noise Measurement Test

Use a capacitor C_{out} (1.0 μ F) measurement. The Scope measurement bandwidth is 0-20MHz.

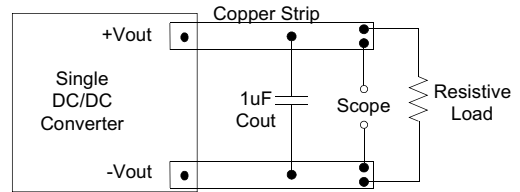

ELECTRICAL CHARACTERISTIC CURVES

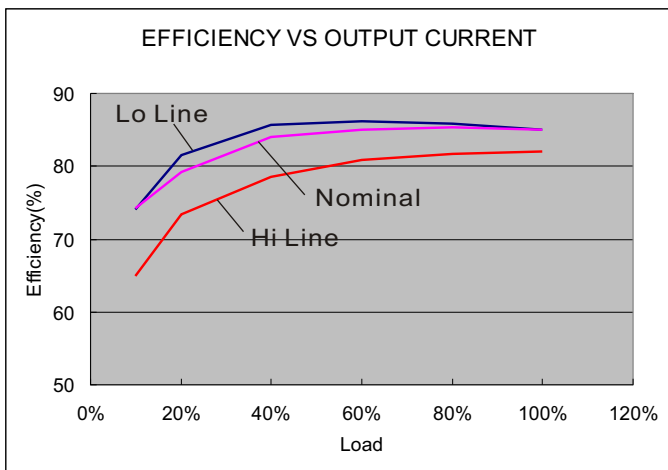

24 Models

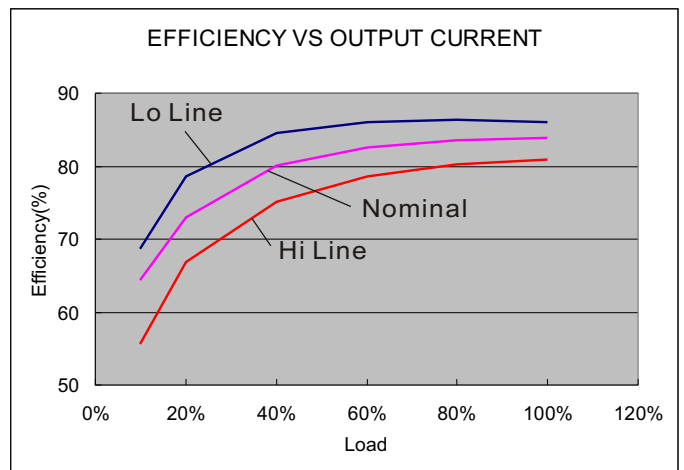

48 Models

The models listed above is just for standard type. If you need the special specification product, please contact our service member by telephone presented in shortform cover or e-mail to : sales@motien.com.tw

V7W - 10W 4:1 Regulated Single & Dual output

MECHANICAL SPECIFICATIONS

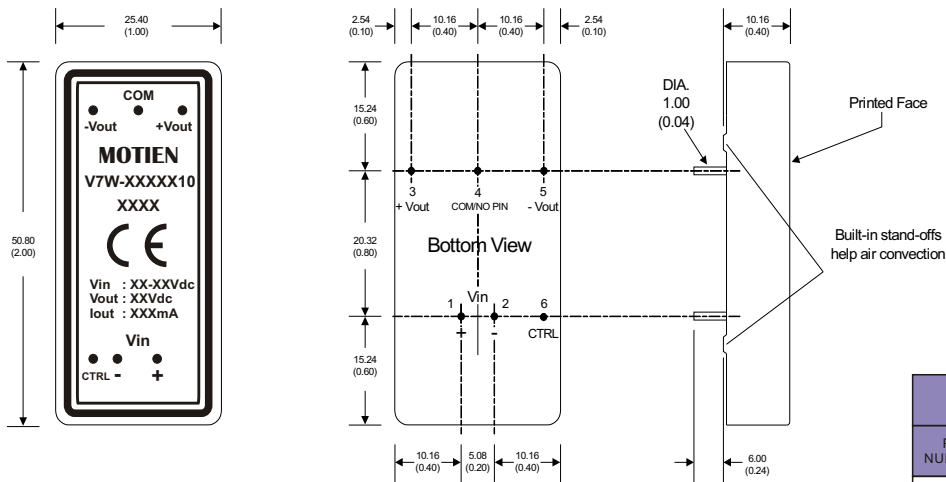

PIN CONNECTIONS				
PIN NUMBER	Standard		Remote Control(Optional)	
	SINGLE	DUAL	SINGLE	DUAL
1	+V Input	+V Input	+V Input	+V Input
2	-V Input	-V Input	-V Input	-V Input
3	+V Output	+V Output	+V Output	+V Output
4	N.P.	Common	N.P.	Common
5	-V Output	-V Output	-V Output	-V Output
6	N.P.	N.P.	CTRL	CTRL

All dimensions are typical in millimeters (inches).

1. Pin diameter: 1.0 ± 0.05 (0.04 ± 0.002)
2. Pin pitch and length tolerance: ± 0.35 (± 0.014)
3. Case Tolerance: ± 0.5 (± 0.02)