

V7E Series

15W 2:1 Regulated Single & Dual output



Features

- Wide 2:1 Input Range
- Full SMD Technology
- 1600~3500 VDC Isolation
- No Minimum Load Required
- Efficiency up to 89%
- Extended Operating Temperature Range -40 ~ 85°C max.
- Continuous Short Circuit Protection
- Over Current Protection
- Soft Start
- EMI Complies With EN55022 Class A

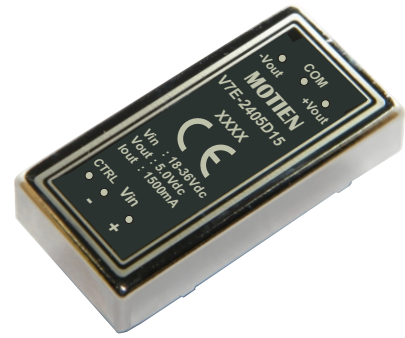

The V7E series is a family of high performance and cost effective 15W single and dual output DC/Dc converters. Encapsulated in a 2"X1" nickel coated brass case, featuring Active clamp switching technology - providing perfect regulation from no load to full load. Which is suitable for network distributed power source. High efficiency up to 89% - Output voltages are available from 3.3V, 5V, 12V, 15V and $\pm 3.3V, \pm 5V, \pm 12V, \pm 15V$ and input ranges of 2:1 ranging from 12V (9V~18V), 24V (18V~36V) and 48V (36V~75V).

ALL SPECIFICATIONS ARE TYPICAL AT 25°C, NOMINAL INPUT AND FULL LOAD UNLESS OTHERWISE NOTED.

OUTPUT SPECIFICATIONS	
Output Voltage Accuracy	$\pm 1\%$
Maximum Output Current	See table
Line Regulation	$\pm 0.5\%$, max.
Load Regulation($I_o=0\%$ to 100%)(1)	Single: $\pm 0.5\%$, max. Dual: $\pm 0.5\%$, max. Dual: $\pm 0.8\%$, max(only $\pm 3.3V$)
Cross Regulation (Dual Output) (2)	$\pm 5\%$
Ripple&Noise (3)	75mVp-p, max.
Over Current Protection	140% of FL, typ.
Short Circuit Protection	Indefinite(hiccup) (Automatic Recovery)
Temperature Coefficient	$\pm 0.02\%/^{\circ}C$
Capacitive Load (4)	See table
Transient Recovery Time (5)	250us, typ.
Transient Response Deviation(5)	$\pm 3\%$, max.
INPUT SPECIFICATIONS	
Input Voltage Range	See table
Under Voltage Lockout	
12V Models	Module ON / OFF 8.6Vdc / 7.9Vdc, typ.
24V Models	Module ON / OFF 17.8Vdc / 16Vdc, typ.
48V Models	Module ON / OFF 33.5Vdc / 30.5Vdc, typ.
Start up Time (Nominal V_{in} and constant resistive load)	20mS, typ.
Input Filter	Pi Type
Input Current(No-Load)	See table, typ.
Input Current(Full-Load)	See table, max.
Input Reflected Ripple Current(6)	20mA _{p-p} , typ.
CTRL(7) Module ON	2.5 to 5.5 Vdc or Open
Module OFF	-0.7 to 0.8Vdc
CTRL OFF Input Current	2.5mA, typ
ENVIRONMENTAL SPECIFICATIONS	
Operating Ambient Temperature	-40°C ~ +85°C(See Derating Curve) -40°C ~ +70°C(For 100% load)
Maximum Case Temperature	100°C
Storage Temperature	-40°C ~ +125°C
Cooling	Nature Convection

EMC SPECIFICATIONS		
Radiated Emissions	EN55022	CLASS A
Conducted Emissions (7)	EN55022	CLASS A
ESD	IEC 61000-4-2	Perf. Criteria A
RS	IEC 61000-4-3	Perf. Criteria A
EFT(8)	IEC 61000-4-4	Perf. Criteria A
Surge(8)	IEC 61000-4-5	Perf. Criteria A
CS	IEC 61000-4-6	Perf. Criteria A
PFMF	IEC 61000-4-8	Perf. Criteria A

GENERAL SPECIFICATIONS	
Efficiency	See table, typ.
I/O Isolation Voltage(3 sec)	
Input/Output	1600Vdc-3500Vdc
Case/Input & Output	1600Vdc
Isolation Resistance	1000 M Ω , min.
Isolation Capacitance	1200 pF, typ.
Switching frequency	300kHz, typ.
Humidity	95% rel H
Reliability Calculated MTBF(MIL-HDBK-217 F)	>1.121 Mhrs
Safety Standard (designed to meet)	IEC/EN 60950-1

PHYSICAL SPECIFICATIONS	
Case Material	Nickel-coated Copper
Pin Material	$\varnothing 1.0\text{mm}$ Brass Solder-coated
Potting Material	Epoxy (UL94V-0 rated)
Weight	30.0g
Dimensions	2.00"x1.00"x0.40"

ABSOLUTE SPECIFICATIONS (9)	
These are stress ratings. Exposure of devices to any of these conditions may adversely affect long-term reliability.	
Input Surge Voltage(100mS)	
12 Models	30 Vdc max.
24 Models	50 Vdc max.
48 Models	100 Vdc max.
Soldering Temperature (1.5mm from case 10 sec. Max.)	260°C max.

The information and specifications contained in this data sheet are believed to be correct at time of publication. However, MOTIEN Technologies accepts no responsibility for consequences arising from printing errors or inaccuracies. Specifications are subject to change without notice. No rights under any patent accompany the sale of any such product(s) or information contained herein.

V7E - 15W 2:1 Regulated Single & Dual output

PART NUMBER STRUCTURE

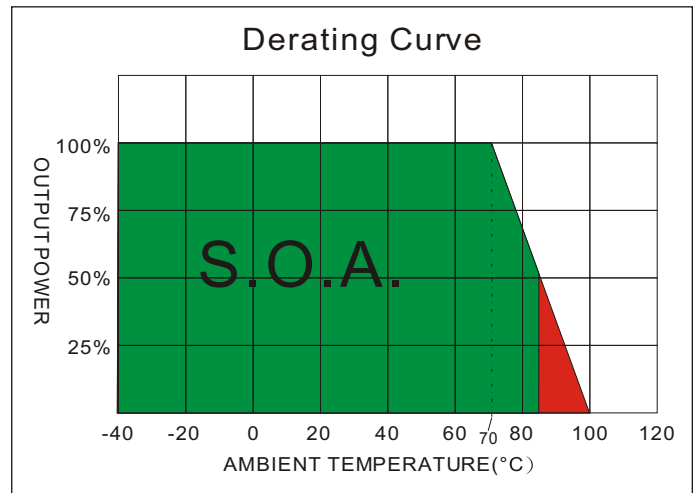
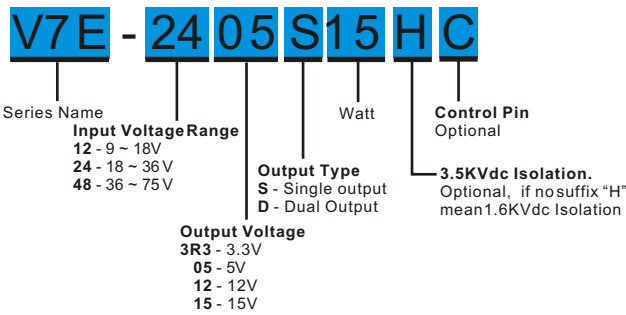

MODEL SELECTION GUIDE

MODEL NUMBER	INPUT Voltage Range (Vdc)	INPUT Current		OUTPUT Voltage (Vdc)	OUTPUT Current		EFFICIENCY @FL (%)	Capacitor Load (uF)
		No-Load (mA)	Full Load (mA)		Min. load (mA)	Full load (mA)		
V7E-123R3S15	9-18	30	1031	3.3	0	3000	82	3300
V7E-1205S15	9-18	30	1524	5	0	3000	84	3300
V7E-1212S15	9-18	30	1453	12	0	1250	88	1000
V7E-1215S15	9-18	30	1436	15	0	1000	89	680
V7E-123R3D15	9-18	30	1031	±3.3	0	±1500	82	±1000
V7E-1205D15	9-18	30	1506	±5	0	±1500	85	±1000
V7E-1212D15	9-18	30	1453	±12	0	±625	88	±470
V7E-1215D15	9-18	30	1453	±15	0	±500	88	±330
V7E-243R3S15	18-36	25	515	3.3	0	3000	82	3300
V7E-2405S15	18-36	25	753	5	0	3000	85	3300
V7E-2412S15	18-36	25	718	12	0	1250	89	1000
V7E-2415S15	18-36	25	718	15	0	1000	89	680
V7E-243R3D15	18-36	25	515	±3.3	0	±1500	82	±1000
V7E-2405D15	18-36	25	753	±5	0	±1500	85	±1000
V7E-2412D15	18-36	25	718	±12	0	±625	88	±470
V7E-2415D15	18-36	25	718	±15	0	±500	88	±330
V7E-483R3S15	36-75	20	257	3.3	0	3000	82	3300
V7E-4805S15	36-75	20	376	5	0	3000	85	3300
V7E-4812S15	36-75	20	359	12	0	1250	89	1000
V7E-4815S15	36-75	20	359	15	0	1000	89	680
V7E-483R3D15	36-75	20	257	±3.3	0	±1500	82	±1000
V7E-4805D15	36-75	20	376	±5	0	±1500	85	±1000
V7E-4812D15	36-75	20	363	±12	0	±625	88	±470
V7E-4815D15	36-75	20	363	±15	0	±500	88	±330

Suffix "H" means 3.5KVdc isolation

NOTE

- Load regulation for dual output: minimum load to full load balanced on all outputs.
- One load is 25% to 100% load, the other load is 100% load, the output voltage variable rate is within ±5%.
- Measured with 20MHz bandwidth and 1.0uF ceramic capacitor.
- Tested by minimal Vin and constant resistive load.
- Tested by normal Vin and 25% load step change (75%-50%-25% of Io).
- Measured Input reflected ripple current with a simulated source inductance of 12uH.
- To order the converter with CTRL function, please add suffix C (e.g. V7E-4812S10C).
- Input filter components (C1, L, C2) are used to help meet conducted emissions requirement for the module. These components should be mounted as close as possible to the module; and all leads should be minimized to decrease radiated noise.
- An external filter capacitor is required if the module has to meet IEC61000-4-4 and IEC61000-4-5.
The filter capacitor Motien suggest: Nippon chemi-con KY series, 220uF/100V.
- Exceeding the absolute ratings of the unit could cause damage. It is not allowed for continuous operating.

The models listed above is just for standard type. If you need the special specification product, please contact our service member by telephone presented in shortform cover or e-mail to : sales@motien.com.tw

TEST CONFIGURATIONS

Input Reflected Ripple Current Test Step

Input reflected ripple current is measured through a source inductor L_{in} (12uH) and a source capacitor C_{in} (47uF, ESR<1.0Ω at 100KHz) at nominal input and full load.

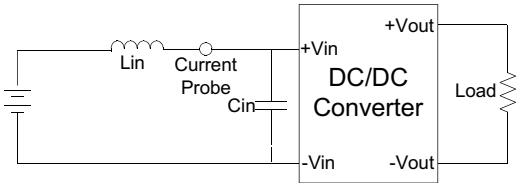

EMI Filter

Input filter components (C_1, L, C_2) are used to help meet conducted emissions requirement for the module. These components should be mounted as close as possible to the module; and all leads should be minimized to decrease radiated noise.

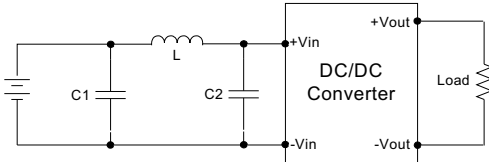

	C1	L	C2
V7E-12XXXXX	330uF/100V	12uH	100uF/100V
V7E-24XXXXX	330uF/100V	12uH	100uF/100V
V7E-48XXXXX	330uF/100V	12uH	100uF/100V

Output Ripple & Noise Measurement Test

Use a capacitor C_{out} (1.0uF) measurement. The Scope measurement bandwidth is 0-20MHz.

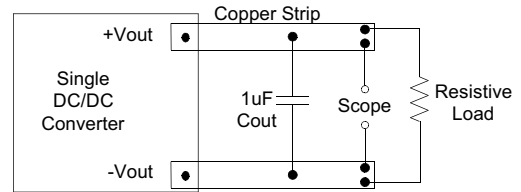

MECHANICAL SPECIFICATIONS

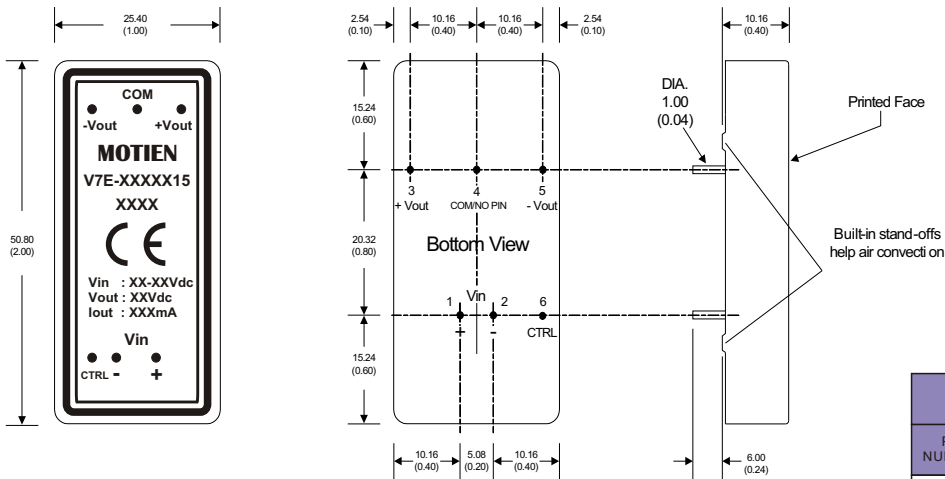

- All dimensions are typical in millimeters (inches).
1. Pin diameter: 1.0 ± 0.05 (0.04 ± 0.002)
 2. Pin pitch and length tolerance: ± 0.35 (± 0.014)
 3. Case Tolerance: ± 0.5 (± 0.02)

PIN NUMBER	Standard		Remote Control (optional)	
	SINGLE	DUAL	SINGLE	DUAL
1	+V Input	+V Input	+V Input	+V Input
2	-V Input	-V Input	-V Input	-V Input
3	+V Output	+V Output	+V Output	+V Output
4	N.P.	Common	N.P.	Common
5	-V Output	-V Output	-V Output	-V Output
6	N.P.	N.P.	CTRL	CTRL

(The Pin Connection of high isolation one is the same with normal one.)