

SERIES: PYB15-T & PYB15-U | **DESCRIPTION:** DC-DC CONVERTER

FEATURES

- up to 15 W isolated output
- industry standard pinout
- 4:1 input range (9~36 Vdc, 18~75 Vdc)
- smaller package
- single/dual regulated outputs
- 1,500 Vdc isolation
- continuous short circuit, over current protection, over voltage protection
- reverse polarity protection on chassis mount (-T) models
- temperature range (-40~85°C)
- six-sided metal shielding
- efficiency up to 90%



| MODEL | input voltage | | output voltage (Vdc) | output current | | output power max (W) | ripple and noise ¹ max (mVp-p) | efficiency ² typ (%) |
|---------------|---------------|----------------|-------------------------|----------------|-------------|----------------------------|---|---------------------------------------|
| | typ (Vdc) | range (Vdc) | | min (mA) | max (mA) | | | |
| PYB15-Q24-S3 | 24 | 9~36 | 3.3 | 200 | 4000 | 13.2 | 100 | 87 |
| PYB15-Q24-S5 | 24 | 9~36 | 5 | 150 | 3000 | 15 | 100 | 90 |
| PYB15-Q24-S12 | 24 | 9~36 | 12 | 63 | 1250 | 15 | 100 | 89 |
| PYB15-Q24-S15 | 24 | 9~36 | 15 | 50 | 1000 | 15 | 100 | 89 |
| PYB15-Q24-S24 | 24 | 9~36 | 24 | 31 | 625 | 15 | 100 | 90 |
| PYB15-Q24-D5 | 24 | 9~36 | ±5 | ±75 | ±1500 | 15 | 100 | 86 |
| PYB15-Q24-D12 | 24 | 9~36 | ±12 | ±32 | ±625 | 15 | 100 | 88 |
| PYB15-Q24-D15 | 24 | 9~36 | ±15 | ±25 | ±500 | 15 | 100 | 88 |
| PYB15-Q48-S3 | 48 | 18~75 | 3.3 | 200 | 4000 | 13.2 | 100 | 87 |
| PYB15-Q48-S5 | 48 | 18~75 | 5 | 150 | 3000 | 15 | 100 | 89 |
| PYB15-Q48-S12 | 48 | 18~75 | 12 | 63 | 1250 | 15 | 100 | 88 |
| PYB15-Q48-S15 | 48 | 18~75 | 15 | 50 | 1000 | 15 | 100 | 90 |
| PYB15-Q48-D5 | 48 | 18~75 | ±5 | ±75 | ±1500 | 15 | 100 | 86 |
| PYB15-Q48-D12 | 48 | 18~75 | ±12 | ±32 | ±625 | 15 | 100 | 88 |
| PYB15-Q48-D15 | 48 | 18~75 | ±15 | ±25 | ±500 | 15 | 100 | 89 |

Notes: 1. Ripple and noise are measured at 20 MHz BW by "parallel cable" method with 1 µF ceramic and 10 µF electrolytic capacitors on the output.
 2. Efficiency is approximately 2% lower for chassis mount (-T) models.

PART NUMBER KEY

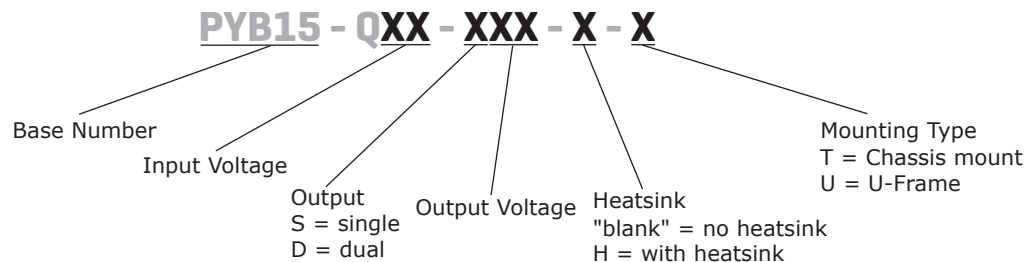

INPUT

| parameter | conditions/description | min | typ | max | units |
|-------------------------------------|---|------|-----|------|-------|
| operating input voltage | 24 Vdc input models | 9 | 24 | 36 | Vdc |
| | 48 Vdc input models | 18 | 48 | 75 | Vdc |
| start-up voltage | 24 Vdc input models | | | 9 | Vdc |
| | 48 Vdc input models | | | 17.8 | Vdc |
| under voltage shutdown ¹ | 24 Vdc input models | 7.5 | | | Vdc |
| | 48 Vdc input models | 16 | | | Vdc |
| surge voltage | for maximum of 1 second | | | | |
| | 24 Vdc input models | -0.7 | | 50 | Vdc |
| | 48 Vdc input models | -0.7 | | 100 | Vdc |
| start-up time | nominal input, constant load | | 10 | | ms |
| filter | pi filter | | | | |
| CTRL ² | models ON (CTRL open or connect TTL high level, 2.5~12 Vdc) | | | | |
| | models OFF (CTRL connect GND or low level, 0~1.2 Vdc) | | | | |
| | input current (models OFF) | | 1 | | mA |

Notes: 1. Contact CUI if you are planning to use this feature in your application.
2. CTRL pin voltage is referenced to GND.

OUTPUT

| parameter | conditions/description | min | typ | max | units |
|------------------------------|---|-----|------|-------|-------|
| line regulation | full load, input voltage from low to high | | ±0.2 | ±0.5 | % |
| load regulation | 5% to 100% load | | ±0.5 | ±1 | % |
| cross regulation | dual output models: main output 50% load, secondary output from 5% to 100% load | | | ±5 | % |
| voltage accuracy | | | ±1 | ±3 | % |
| voltage balance | dual output, balanced loads | | ±0.5 | ±1 | % |
| adjustability ³ | | | ±10 | | % |
| switching frequency | PWM mode | | 300 | | kHz |
| transient recovery time | 25% load step change | | 300 | 500 | µs |
| transient response deviation | 25% load step change | | ±3 | ±5 | % |
| temperature coefficient | 100% load | | | ±0.02 | %/°C |

Note: 3. Output trimming available on single output models only.

PROTECTIONS

| parameter | conditions/description | min | typ | max | units |
|--------------------------|--|-----|-----|-----|-------|
| short circuit protection | hiccup, continuous, automatic recovery | | | | |
| over current protection | | | 160 | | % |
| over voltage protection | 3.3 Vdc output models | | 3.9 | | Vdc |
| | 5 Vdc output models | | 6.2 | | Vdc |
| | 12 Vdc output models | | 15 | | Vdc |
| | 15 Vdc output models | | 18 | | Vdc |
| | 24 Vdc output models | | 30 | | Vdc |

SAFETY AND COMPLIANCE

| parameter | conditions/description | min | typ | max | units |
|------------------------------|---|-----------|-----|-----|-------|
| isolation voltage | for 1 minute at 1 mA max. | 1,500 | | | Vdc |
| isolation resistance | at 500 Vdc | 1,000 | | | MΩ |
| conducted emissions | CISPR22/EN55022, class A, class B (external circuit required, see Figure 1-b) | | | | |
| radiated emissions | CISPR22/EN55022, class A, class B (external circuit required, see Figure 1-b) | | | | |
| ESD | IEC/EN61000-4-2, class B, contact ± 4kV | | | | |
| radiated immunity | IEC/EN61000-4-3, class A, 10V/m | | | | |
| EFT/burst | IEC/EN61000-4-4, class B, ± 2kV (external circuit required, see Figure 1-a) | | | | |
| surge | IEC/EN61000-4-5, class B, ± 2kV (external circuit required, see Figure 1-a) | | | | |
| conducted immunity | IEC/EN61000-4-6, class A, 3 Vr.m.s | | | | |
| voltage dips & interruptions | IEC/EN61000-4-29, class B, 0%-70% | | | | |
| MTBF | as per MIL-HDBK-217F @ 25°C | 1,000,000 | | | hours |
| RoHS | 2011/65/EU | | | | |

ENVIRONMENTAL

| parameter | conditions/description | min | typ | max | units |
|-----------------------|--|-----|-----|-----|-------|
| operating temperature | see derating curves | -40 | | 85 | °C |
| storage temperature | | -55 | | 125 | °C |
| storage humidity | non-condensing | 5 | | 95 | % |
| case temperature | at full load, Ta=71°C | | | 105 | °C |
| vibration | 10~55 Hz for 30 min. along X, Y and Z axis | | 10 | | G |

MECHANICAL

| parameter | conditions/description | min | typ | max | units |
|---------------|--|-----|-----|-----|-------|
| dimensions | chassis mount: 76 x 31.5 x 21.2 | | | | mm |
| | chassis mount with heatsink: 76 x 31.5 x 25.10 | | | | mm |
| | U-Frame: 52.32 x 54.99 x 19.05 | | | | mm |
| | U-Frame with heatsink: 52.32 x 54.99 x 22.90 | | | | mm |
| case material | aluminum alloy | | | | |
| weight | chassis mount | | 50 | | g |
| | chassis mount with heatsink | | 58 | | g |
| | U-Frame | | 58 | | g |
| | U-Frame with heatsink | | 66 | | g |

MECHANICAL DRAWING

CHASSIS MOUNT

units: mm[inch]
tolerance: $\pm 0.5[\pm 0.02]$

wire range: 24~12 AWG

| PIN CONNECTIONS | | |
|-----------------|---------------|-------------|
| PIN | Single Output | Dual Output |
| 1 | CTRL | CTRL |
| 2 | GND | GND |
| 3 | Vin | Vin |
| 4 | 0V | -Vo |
| 5 | Trim | 0V |
| 6 | +Vo | +Vo |

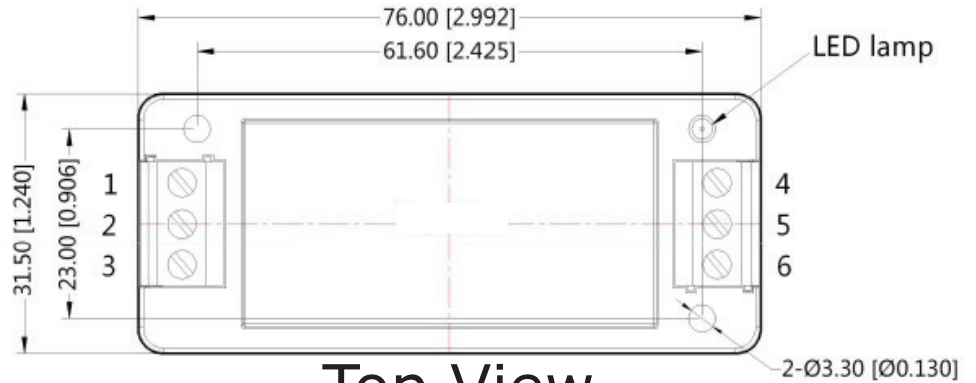

Top View

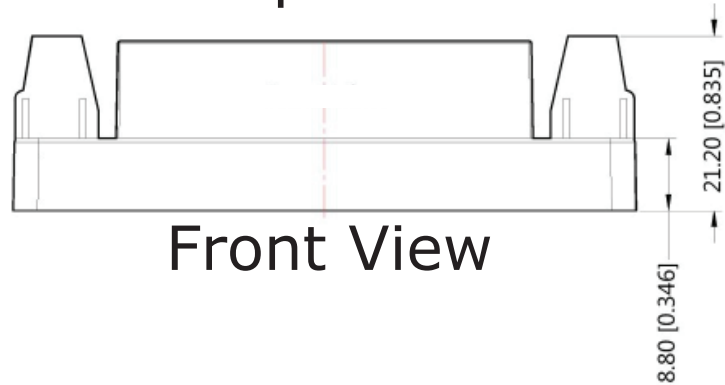

Front View

CHASSIS MOUNT WITH HEATSINK

units: mm[inch]
tolerance: $\pm 0.5[\pm 0.02]$

wire range: 24~12 AWG

| PIN CONNECTIONS | | |
|-----------------|---------------|-------------|
| PIN | Single Output | Dual Output |
| 1 | CTRL | CTRL |
| 2 | GND | GND |
| 3 | Vin | Vin |
| 4 | 0V | -Vo |
| 5 | Trim | 0V |
| 6 | +Vo | +Vo |

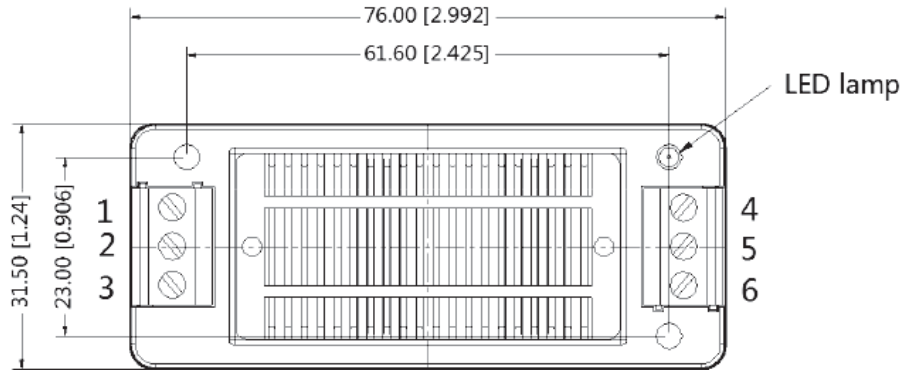

Top View

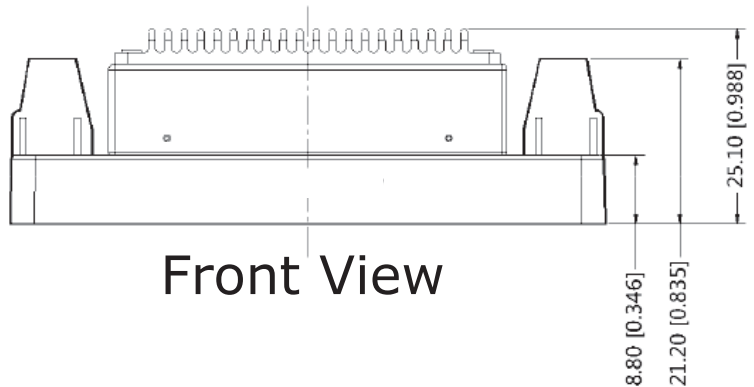

Front View

MECHANICAL DRAWING (CONTINUED)

U-FRAME

units: mm[inch]
tolerance: $\pm 0.5[\pm 0.020]$

Wire range: 22~14 AWG
DIN rail mounting kit available
(part# STK-DIN)

| PIN CONNECTIONS | | |
|-----------------|---------------|-------------|
| PIN | Single Output | Dual Output |
| 1 | GND | GND |
| 2 | Vin | Vin |
| 3 | CTRL | CTRL |
| 4 | Case | Case |
| 5 | NC | NC |
| 6 | +Vo | +Vo |
| 7 | Trim | 0V |
| 8 | 0V | -Vo |

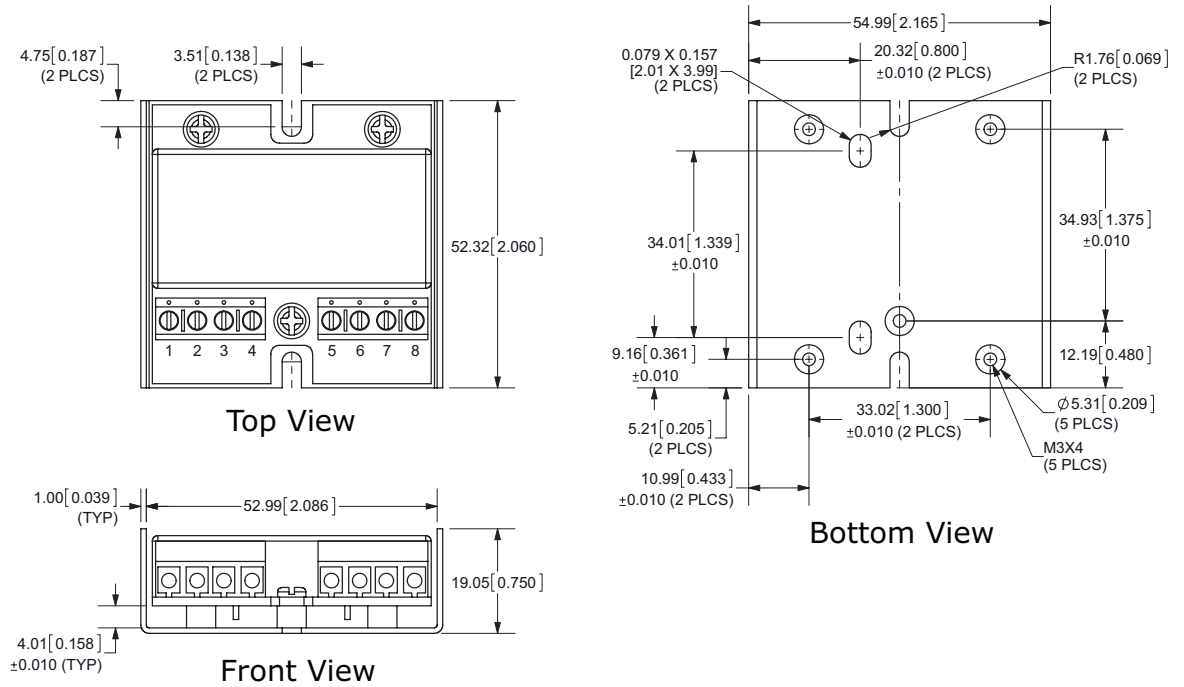

U-FRAME WITH HEATSINK

units: mm[inch]
tolerance: $\pm 0.5[\pm 0.020]$

Wire range: 22~14 AWG
DIN rail mounting kit available
(part# STK-DIN)

| PIN CONNECTIONS | | |
|-----------------|---------------|-------------|
| PIN | Single Output | Dual Output |
| 1 | GND | GND |
| 2 | Vin | Vin |
| 3 | CTRL | CTRL |
| 4 | Case | Case |
| 5 | NC | NC |
| 6 | +Vo | +Vo |
| 7 | Trim | 0V |
| 8 | 0V | -Vo |

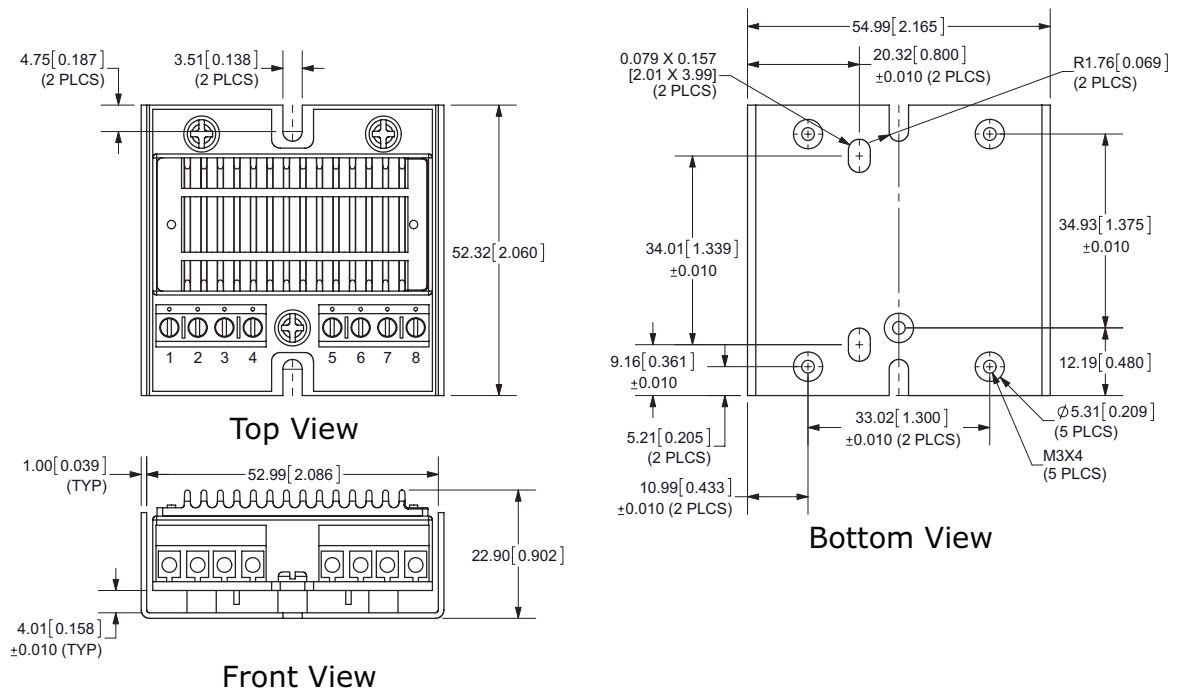

DERATING CURVES

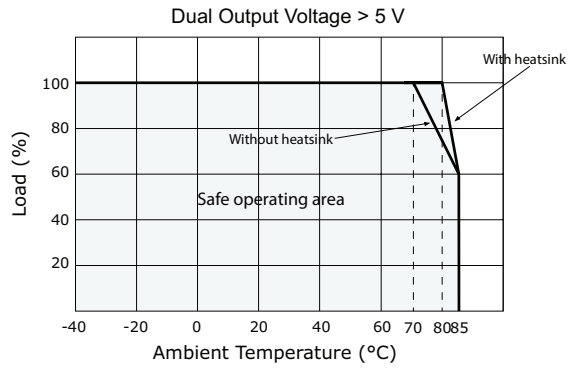
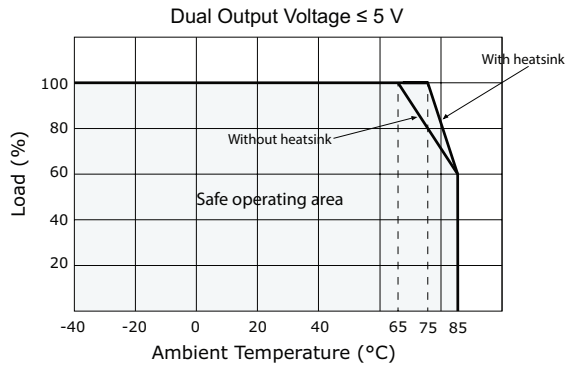
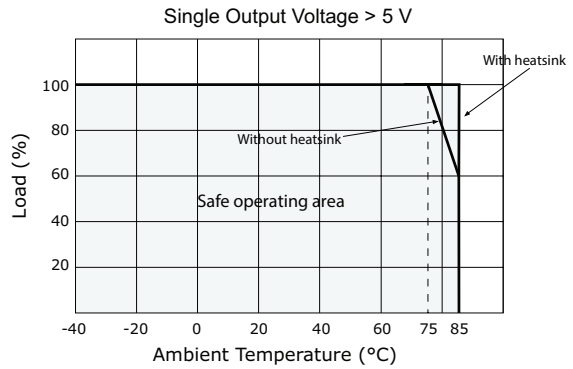
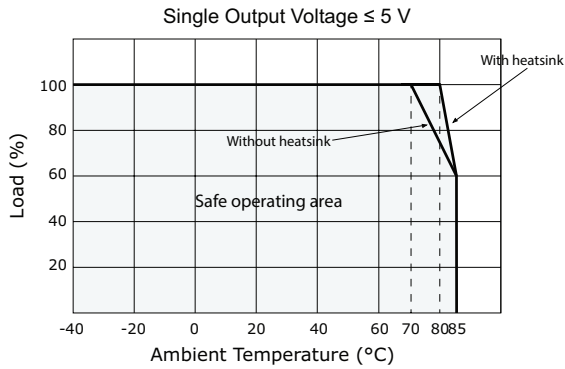

EMC RECOMMENDED CIRCUIT

Figure 1

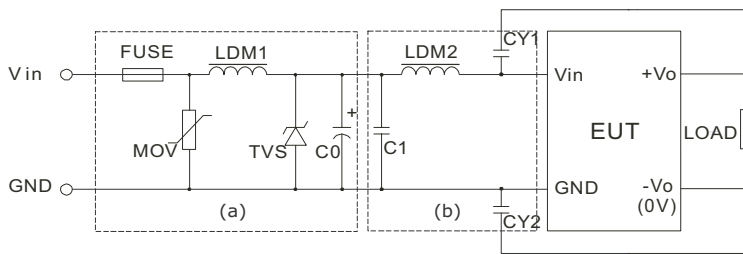

Table 1

| Recommended external circuit components | | |
|---|-----------------------------------|------------|
| Vin (Vdc) | 24 | 48 |
| FUSE | Choose according to input current | |
| MOV | S14K35 | S14K60 |
| LDM1 | 56μH | 56μH |
| TVS | SMCJ48A | SMCJ90A |
| C0 | 330μF/50V | 330μF/100V |
| C1 | 1μF/50V | 1μF/100V |
| LDM2 | 4.7μH | 4.7μH |
| CY1 | 1nF/2kV | 1nF/2kV |
| CY2 | 1nF/2kV | 1nF/2kV |

TEST CONFIGURATION

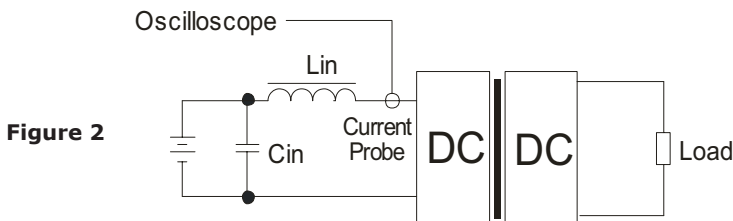

Table 2

| External components | |
|---------------------|------------------------------|
| Lin | 4.7μH |
| Cin | 220μF, ESR < 1.0Ω at 100 kHz |

Note: Input reflected-ripple current is measured with an inductor Lin and Capacitor Cin to simulate source impedance.

APPLICATION NOTES

1. Recommended circuit

This series has been tested according to the following recommended testing circuit before leaving the factory. This series should be tested under load (see Figure 3). If you want to further decrease the input/output ripple, you can increase the capacitance accordingly or choose capacitors with low ESR (see Table 3). However, the capacitance of the output filter capacitor must be appropriate. If the capacitance is too high, a startup problem might arise. For every channel of the output, to ensure safe and reliable operation, the maximum capacitance must be less than the maximum capacitive load (see Table 4).

Single Output



Figure 3

Dual Output



Table 3

| Single Vout (Vdc) | Cin (μF) | Cout (μF) | Dual Vout (Vdc) | Cin (μF) | Cout ¹ (μF) |
|-------------------|----------|-----------|-----------------|----------|------------------------|
| 3.3 | 100 | 470 | ±5 | 100 | 220 |
| 5 | 100 | 470 | ±12 | 100 | 100 |
| 12 | 100 | 220 | ±15 | 100 | 100 |
| 15 | 100 | 220 | -- | -- | -- |
| 24 | 100 | 100 | -- | -- | -- |

Note: 1. For each output.

Table 4

| Single Vout (Vdc) | Max. Capacitive Load (μF) | Dual Vout (Vdc) | Max. Capacitive Load ¹ (μF) |
|-------------------|---------------------------|-----------------|--|
| 3.3 | 10200 | -- | -- |
| 5 | 4020 | 5 | 4800 |
| 12 | 1035 | 12 | 800 |
| 15 | 705 | 15 | 500 |
| 24 | 470 | -- | -- |

Note: 1. For each output.

2. Output voltage trimming

Leave open if not used.

Figure 4

Application Circuit for Trim pin
(part in broken line is the interior of models)

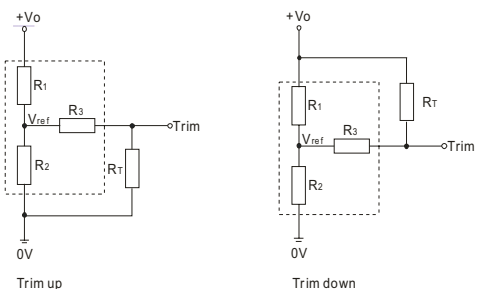

Formula for Trim Resistor

$$\begin{aligned} \text{up: } R_T &= \frac{aR_2}{R_2 - a} - R_3 & a &= \frac{V_{ref}}{V_o' - V_{ref}} \cdot R_1 \\ \text{down: } R_T &= \frac{aR_1}{R_1 - a} - R_3 & a &= \frac{V_o' - V_{ref}}{V_{ref}} \cdot R_2 \end{aligned}$$

Note: Value for R1, R2, R3, and Vref refer to Table 5
R_T: Trim Resistor
a: User-defined parameter, no actual meanings
V_{o'}: The trim up/down voltage

Table 5

| Vout (Vdc) | R1 (kΩ) | R2 (kΩ) | R3 (kΩ) | Vref (V) |
|------------|---------|---------|---------|----------|
| 3.3 | 4.801 | 2.863 | 15 | 1.24 |
| 5 | 2.883 | 2.864 | 10 | 2.5 |
| 12 | 10.971 | 2.864 | 17.8 | 2.5 |
| 15 | 14.497 | 2.864 | 17.8 | 2.5 |
| 24 | 24.872 | 2.863 | 20 | 2.5 |

Note: 1. Minimum load shouldn't be less than 5%, otherwise ripple may increase dramatically. Operation under minimum load will not damage the converter, however, they may not meet all specifications listed.
2. Maximum capacitive load is tested at input voltage range and full load.
3. All specifications are measured at Ta=25°C, humidity<75%, nominal input voltage and rated output load unless otherwise specified.

REVISION HISTORY

| rev. | description | date |
|------|-----------------|------------|
| 1.0 | initial release | 06/26/2013 |
| 1.01 | updated spec | 08/16/2013 |
| 1.02 | updated spec | 08/18/2014 |

The revision history provided is for informational purposes only and is believed to be accurate.



Headquarters
20050 SW 112th Ave.
Tualatin, OR 97062
800.275.4899

Fax 503.612.2383
cui.com
techsupport@cui.com

CUI offers a two (2) year limited warranty. Complete warranty information is listed on our website.

CUI reserves the right to make changes to the product at any time without notice. Information provided by CUI is believed to be accurate and reliable. However, no responsibility is assumed by CUI for its use, nor for any infringements of patents or other rights of third parties which may result from its use.

CUI products are not authorized or warranted for use as critical components in equipment that requires an extremely high level of reliability. A critical component is any component of a life support device or system whose failure to perform can be reasonably expected to cause the failure of the life support device or system, or to affect its safety or effectiveness.