

SERIES: 6 W WALL PLUG - UK BLADE | **DESCRIPTION:** AC-DC POWER SUPPLY

FEATURES

- up to 6 W power
- universal input (90~264 Vac)
- single regulated output from 5~12 V
- over voltage, over current, and short circuit protections
- TUV safety approvals
- level V efficiency
- custom designs available



MODEL	output voltage (Vdc)	output current max (A)	output power max (W)	ripple and noise ¹ max (mVp-p)	efficiency level
EP5A050120UB	5	1.2	6	50	V
EP5A120050UB	12	0.5	6	120	V

Notes: 1. At full load, 100 ~ 240 Vac input, 20 MHz bandwidth oscilloscope, each output terminated with 10 μF aluminum electrolytic and 0.1 μF ceramic capacitors.

PART NUMBER KEY

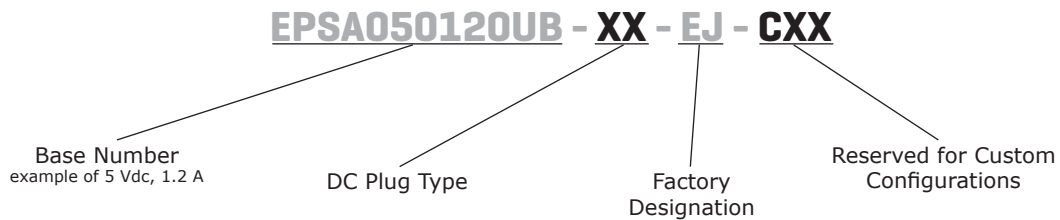

INPUT

parameter	conditions/description	min	nom	max	units
voltage		90		264	Vac
frequency		47		63	Hz
current				0.18	A

OUTPUT

parameter	conditions/description	min	nom	max	units
line regulation			±5		%
load regulation			±5		%
start-up				2	s
hold-up	at 110 Vac, 50 Hz, 80% max. load	10			ms

PROTECTIONS

parameter	conditions/description	min	nom	max	units
over voltage protection	output shut down				
over current protection				200	%
short circuit protection	output shut down and auto restart				

SAFETY & COMPLIANCE

parameter	conditions/description	min	nom	max	units
isolation voltage	input to output at 10 mA for 2 seconds			3,000	Vac
isolation resistance	input to output at 500 Vdc	10			MΩ
safety approvals	EN 60950-1, CE				
EMI/EMC	EN 55022 Class B, AS/NZS CISPR 22 Class B, EN 61000-3-(2,3), IEC 61000-4-(2,3,4,5,6,8,11)				
leakage current				0.25	mA
RoHS compliant	yes				
MTBF	at full load, 25°C, Telcordia SR-332, Issue 2			300,000	hours

ENVIRONMENTAL

parameter	conditions/description	min	nom	max	units
operating temperature		0		40	°C
storage temperature		-25		85	°C
operating humidity		10		95	%
storage humidity		10		95	%

MECHANICAL

parameter	conditions/description	min	typ	max	units
dimensions	2.953 x 1.968 x 1.457 (75 x 50 x 37 mm)				inch
input plug	fixed UK				

MECHANICAL DRAWING

units: mm[inch]

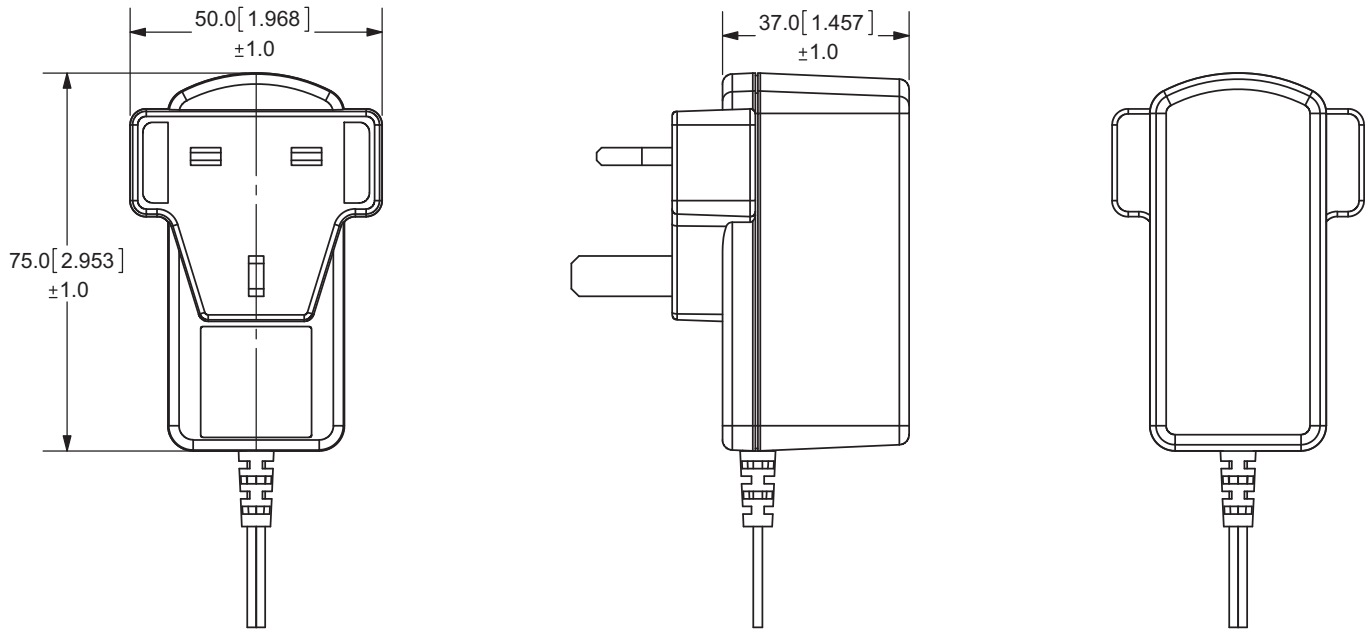

DC CORD

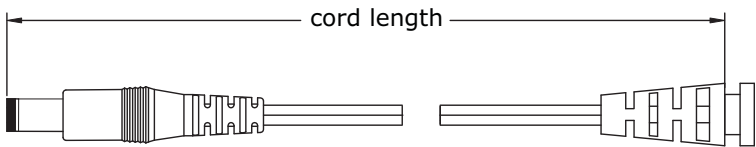

MODEL NO.	CABLE GAUGE	CORD LENGTH
EP5A050120UB	22 AWG	1,530 mm +50/-30
EP5A120050UB	24 AWG	1,530 mm +50/-30

OUTPUT PLUG OPTIONS

3.5 mm Phono Plug

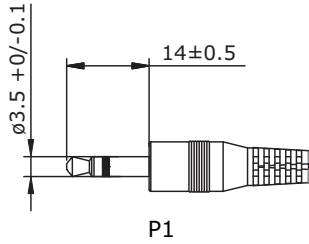

P1

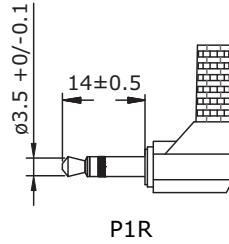

P1R

*Tip positive

Standard DC Plug

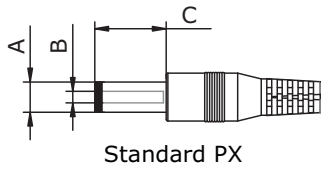

Standard PX

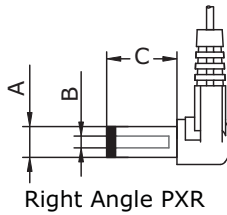

Right Angle PXR

	A	B	C	Unit
P5/P5R	5.5	2.1	9.5	mm
P6/P6R	5.5	2.5	9.5	mm
P7/P7R	3.5	1.35	9.5	mm
P8/P8R	3.8	1.35	9.5	mm
P9/P9R	3.8	1.05	9.5	mm

Locking DC Plug

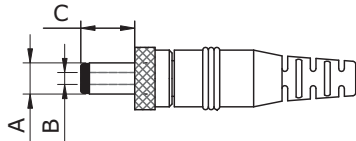

	A	B	C	Unit
P10	5.5	2.1	9.5	mm
P11	5.5	2.5	9.5	mm

EIAJ Plugs

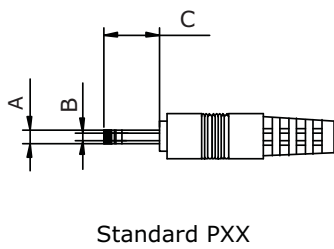

Standard PXX

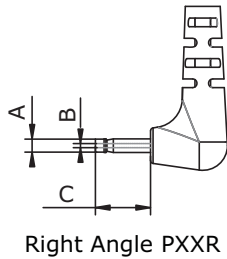

Right Angle PXXR

	EIAJ	A	B	C	D	Unit
P12/P12R	EIAJ-1	2.35	0.7	9.5	NA	mm
P13/P13R	EIAJ-2	4.0	1.7	9.5	5.0	mm
P14/P14R	EIAJ-3	4.75	1.7	9.5	5.0	mm

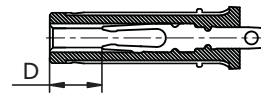

Stripped and Tinned

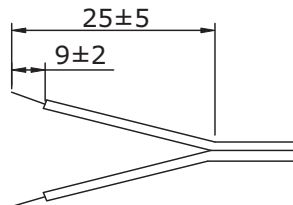

DC PLUG TYPE

ST
Stripped and Tinned

PXXXX

Plug Type Plug Angle:
"Blank" = Standard
R = Right Angle Plug Polarity:
"Blank" = N/A
P = Center Positive ⊖ ⊕ ⊕
N = Center Negative ⊕ ⊖ ⊖

*Contact CUI for additional output plug options.

REVISION HISTORY

rev.	description	date
1.0	initial release	02/01/2010
1.01	updated output plug options	11/11/2010
1.02	updated inrush current, protection data, and output plug options	12/09/2010
1.03	new template applied	01/24/2012
1.04	updated P7/P7R B dimension	03/14/2012
1.05	V-Infinity branding removed, safety and EMI/EMC data updated	08/21/2012

The revision history provided is for informational purposes only and is believed to be accurate.



CUI INC[®]

Headquarters
20050 SW 112th Ave.
Tualatin, OR 97062
800.275.4899

Fax 503.612.2383
cui.com
techsupport@cui.com

CUI offers a one (1) year limited warranty. Complete warranty information is listed on our website.

CUI reserves the right to make changes to the product at any time without notice. Information provided by CUI is believed to be accurate and reliable. However, no responsibility is assumed by CUI for its use, nor for any infringements of patents or other rights of third parties which may result from its use.

CUI products are not authorized or warranted for use as critical components in equipment that requires an extremely high level of reliability. A critical component is any component of a life support device or system whose failure to perform can be reasonably expected to cause the failure of the life support device or system, or to affect its safety or effectiveness.