

**SERIES:** VSK-S10-T | **DESCRIPTION:** AC-DC POWER SUPPLY

**FEATURES**

- up to 10 W continuous output
- encapsulated compact case
- universal input (85~264 Vac)
- single regulated output from 3.3~24 V
- over voltage, short circuit, and short circuit protection
- CE, UL safety approval
- efficiency up to 80%



MODEL	output voltage	output current	output power	ripple and noise	efficiency
	(Vdc)	max (A)	max (W)	typ (mVp-p)	max (%)
VSK-S10-3R3UA-T	3.3	2	6.6	50	70
VSK-S10-5UA-T	5	2	10	50	74
VSK-S10-9UA-T	9	1.1	10	50	76
VSK-S10-12UA-T	12	0.9	10.8	50	76
VSK-S10-15UA-T	15	0.7	10.5	50	78
VSK-S10-24UA-T	24	0.45	10.8	50	80

**PART NUMBER KEY**

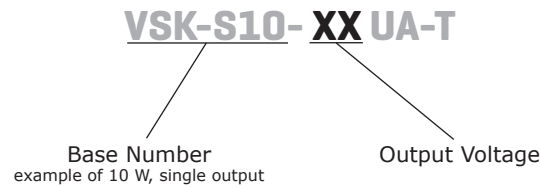

## INPUT

parameter	conditions/description	min	typ	max	units
voltage		85 120		264 370	Vac Vdc
frequency		47		440	Hz
current	at 110 Vac at 230 Vac		230 150		mA mA
inrush current	at 110 Vac at 230 Vac		10 20		A A
input fuse	2 A / 250 V, slow-blow type (internally included)				

## OUTPUT

parameter	conditions/description	min	typ	max	units
line regulation			±0.5		%
load regulation	at 10~100% load		±1		%
voltage set accuracy	3.3 V model all other models		±3 ±2		% %
hold-up time	at 230 Vac		50		ms
switching frequency			60		kHz
temperature coefficient			0.02		%/°C

## PROTECTIONS

parameter	conditions/description	min	typ	max	units
over current protection		110			%
short circuit protection	shutdown and auto restart				

## SAFETY & COMPLIANCE

parameter	conditions/description	min	typ	max	units
isolation voltage	for 1 minute	4,000			Vac
safety approvals	UL 60950				
safety class	Class II				
conducted emissions	CISPR22/EN55022 Class A, Class B (external circuit required, see figure 1)				
radiated emissions	CISPR22/EN55022 Class A, Class B (external circuit required, see figure 1)				
ESD	IEC/EN61000-4-2 Class B, contact ±6 kV / air ±8 kV				
radiated immunity	IEC/EN61000-4-3 Class A, 10V/m				
EFT/burst	IEC/EN61000-4-4 Class B, ±2 kV IEC/EN61000-4-4 Class B, ±4 kV (external circuit required, see figure 1)				
surge	IEC/EN61000-4-5 Class B, ±1 kV IEC/EN61000-4-5 Class B, ±2 kV / ±4 kV (external circuit required, see figure 1)				
conducted immunity	IEC/EN61000-4-6 Class A, 10 Vr.m.s				
PFM	IEC/EN61000-4-8 Class A, 10 A/m				
voltage dips & interruptions	IEC/EN61000-4-11 Class B, 0%-70%				
leakage current	at 230 Vac		0.1		mA
MTBF	at 25°C, max. load	300,000			hours
RoHS compliant	yes				

## ENVIRONMENTAL

parameter	conditions/description	min	typ	max	units
operating temperature	see derating curves	-25		70	°C
storage temperature		-40		105	°C
case temperature				95	°C
humidity	non-condensing			95	%

## DERATING CURVES

1. output power vs. ambient temperature

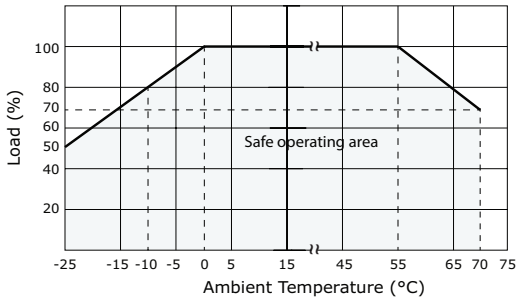

2. output power vs. input voltage (ac)

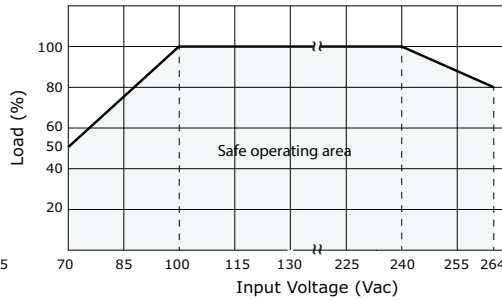

3. output power vs. input voltage (dc)

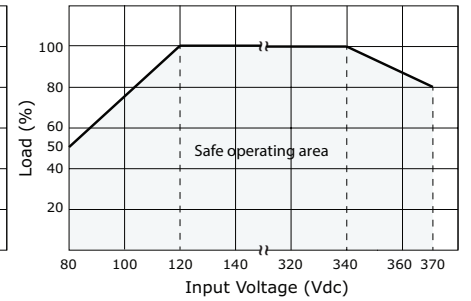

## MECHANICAL

parameter	conditions/description	min	typ	max	units
dimensions	76 x 31.5 x 27.8 (2.992 x 1.240 x 1.094 inch)				mm
material	UL94V-0				
weight			70		g

## MECHANICAL DRAWING

units: mm [inches]  
tolerance: ±0.50 [±0.020]

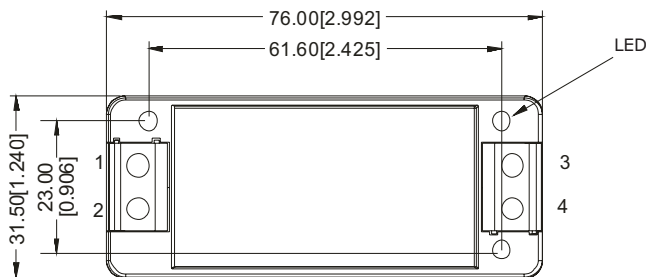

Top View

PIN CONNECTIONS	
PIN	FUNCTION
1	AC(N)
2	AC(L)
3	+Vo
4	-Vo

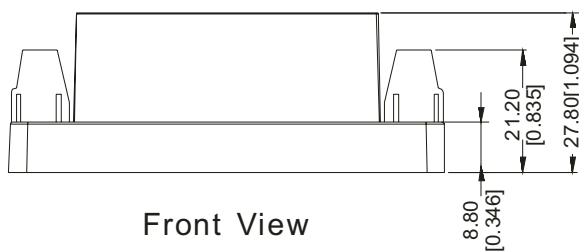

Front View

## TYPICAL APPLICATION CIRCUIT

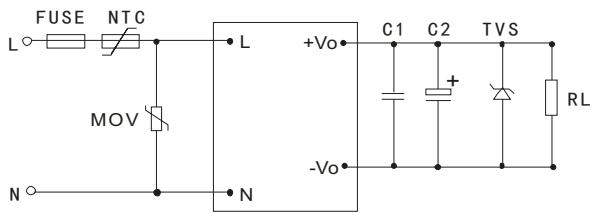

External Capacitors Typical Value (Unit: $\mu\text{F}$ )			
MODEL	C1	C2	TVS
VSK-S10-3R3UA-T	1 $\mu\text{F}$ / 50V	220 $\mu\text{F}$ / 10V	SMBJ7.0A
VSK-S10-5UA-T	1 $\mu\text{F}$ / 50V	220 $\mu\text{F}$ / 10V	SMBJ7.0A
VSK-S10-9UA-T	1 $\mu\text{F}$ / 50V	120 $\mu\text{F}$ / 25V	SMBJ12A
VSK-S10-12UA-T	1 $\mu\text{F}$ / 50V	120 $\mu\text{F}$ / 25V	SMBJ20A
VSK-S10-15UA-T	1 $\mu\text{F}$ / 50V	120 $\mu\text{F}$ / 25V	SMBJ20A
VSK-S10-24UA-T	1 $\mu\text{F}$ / 50V	68 $\mu\text{F}$ / 35V	SMBJ30A

- Notes:
- Output filtering capacitor C2 is an electrolytic capacitor. It is recommended to use high frequency and low impedance electrolytic capacitors. For capacitance and current of capacitor please refer to the manufacturer's datasheet. Voltage derating of capacitor should be 80% or above. C1 is a ceramic capacitor that is used to filter high frequency noise. TVS is a recommended component to protect post-circuits (if converter fails). External input NTC model is recommended to use 5D-9
  - The fuse is internally included, it does not need to be added to the circuit.

## EMC RECOMMENDED CIRCUIT

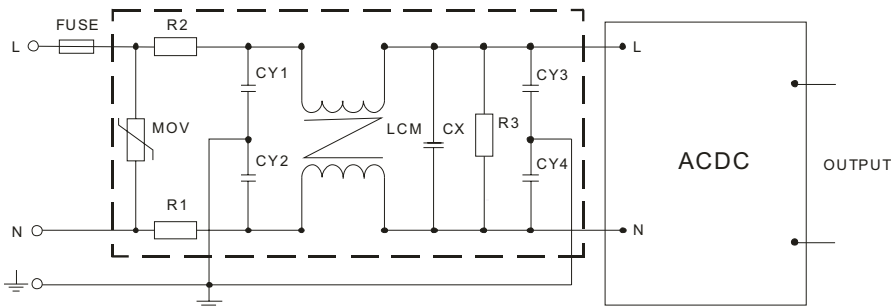
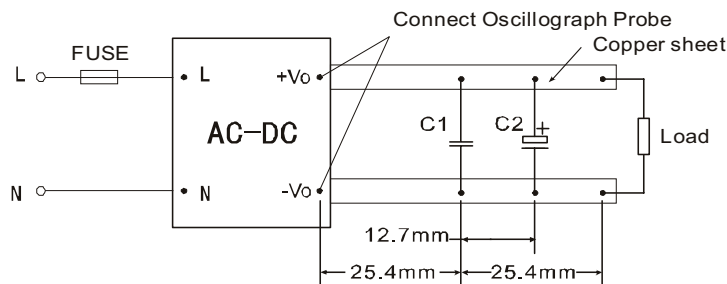

Figure 1

Recommended external circuit components	
MOV	561KD14
R1, R2	2 $\Omega$ /3W winding resistor
R3	1M $\Omega$ /2W
CY1, CY2, CY3, CY4	1000pF/400Vac
CX	0.22 $\mu\text{F}$ /275Vac
LCM	10mH-30mH

## TEST CONFIGURATION



Capacitors	
C1	1 $\mu\text{F}$ ceramic capacitor
C2	10 $\mu\text{F}$ electrolytic capacitor

- Notes:
- All specifications measured at  $T_a=25\text{C}$ , humidity <75%, 220 Vac input voltage, and rated output load, unless otherwise specified.

## REVISION HISTORY

---

rev.	description	date
1.0	initial release	09/06/2012
1.01	updated mechanical drawing and product photo	11/28/2012
1.02	updated spec	03/08/2013

The revision history provided is for informational purposes only and is believed to be accurate.



**Headquarters**  
20050 SW 112th Ave.  
Tualatin, OR 97062  
**800.275.4899**

Fax 503.612.2383  
**cui.com**  
techsupport@cui.com

CUI offers a two (2) year limited warranty. Complete warranty information is listed on our website.

CUI reserves the right to make changes to the product at any time without notice. Information provided by CUI is believed to be accurate and reliable. However, no responsibility is assumed by CUI for its use, nor for any infringements of patents or other rights of third parties which may result from its use.

CUI products are not authorized or warranted for use as critical components in equipment that requires an extremely high level of reliability. A critical component is any component of a life support device or system whose failure to perform can be reasonably expected to cause the failure of the life support device or system, or to affect its safety or effectiveness.