

SERIES: VSK-S20-T | **DESCRIPTION:** AC-DC POWER SUPPLY

FEATURES

- up to 20 W continuous output
- encapsulated compact case
- output short circuit protection
- over current protection
- thermal protection
- CE, UL safety approval
- regulated output
- universal input (85~264 Vac)
- efficiency up to 85%



MODEL	output voltage (Vdc)	output current max (A)	output power max (W)	ripple and noise max (mVp-p)	efficiency max (%)
VSK-S20-3R3U-T	3.3	4.1	14	100	73
VSK-S20-5U-T	5	3.5	18	100	75
VSK-S20-9U-T	9	2.1	19	100	77
VSK-S20-12U-T	12	1.6	19	100	81
VSK-S20-15U-T	15	1.3	20	100	83
VSK-S20-24U-T	24	0.85	20	100	85

PART NUMBER KEY

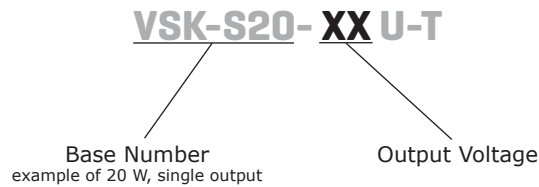

INPUT

parameter	conditions/description	min	typ	max	units
voltage		85 120		264 370	Vac Vdc
frequency		47		63	Hz
input current	at 110 Vac at 230 Vac		330 180		mA mA
inrush current	at 110 Vac at 230 Vac		16 30		A A
recommended external input fuse	3.15 A / 250 V, slow-blow type				

OUTPUT

parameter	conditions/description	min	typ	max	units
voltage set accuracy			±2		%
line regulation			±0.5		%
load regulation	at 10~100% load		±1		%
minimum load		0			%
hold-up time	at 230 Vac		80		ms
temperature coefficient			0.02		%/°C
switching frequency			65		kHz

PROTECTIONS

parameter	conditions/description	min	typ	max	units
over voltage protection	3.3 and 5 V models 9 V model 12 and 15 V models 24 V model			7.5 12 20 30	Vdc Vdc Vdc Vdc
overload protection		110			%
short circuit protection	shutdown and auto restart				

SAFETY & COMPLIANCE

parameter	conditions/description	min	typ	max	units
isolation voltage	for 1 minute			3,000	Vac
safety approvals	EN 60950-1, IEC 60950-1, UL 60950-1				
safety class	Class I				
EMI/EMC	CISPR22/EN 55022 class B, IEC/EN 61000-4-(2, 3, 4, 5)				
leakage current	at 230 Vac, 50 Hz			0.3	mA
MTBF	at 25°C, max. load	300,000			hours
RoHS compliant	yes				

ENVIRONMENTAL

parameter	conditions/description	min	typ	max	units
operating temperature		-40		70	°C
storage temperature		-40		105	°C
case temperature				90	°C
humidity	non-condensing			85	%

DERATING CURVES

1. output power vs. ambient temperature
5 V model

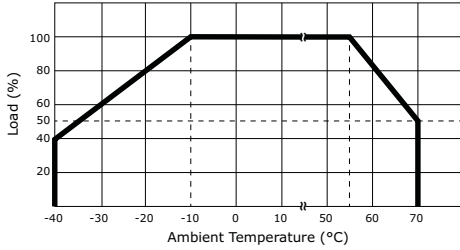

all other models

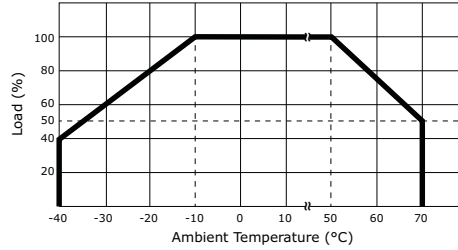

2. output power vs. input voltage

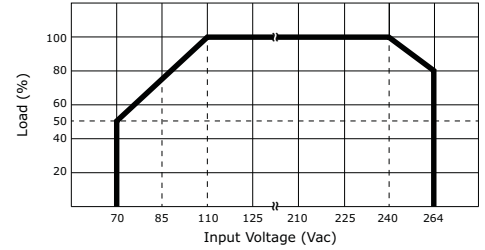

MECHANICAL

parameter	conditions/description	min	typ	max	units
dimensions	3.783 x 2.126 x 1.26 (96.1 x 54 x 32 mm)				inch
weight			170		g

MECHANICAL DRAWING

units: mm [inches]
tolerance: ±0.50 [±0.020]

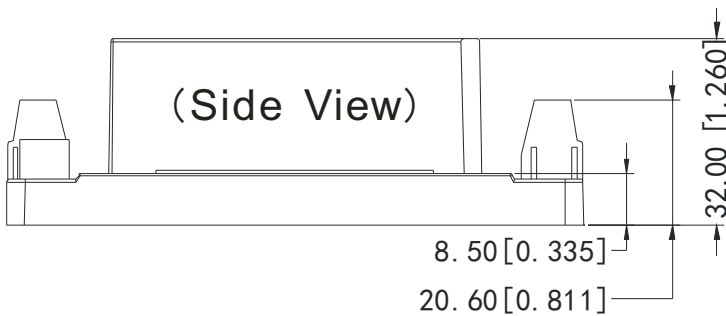
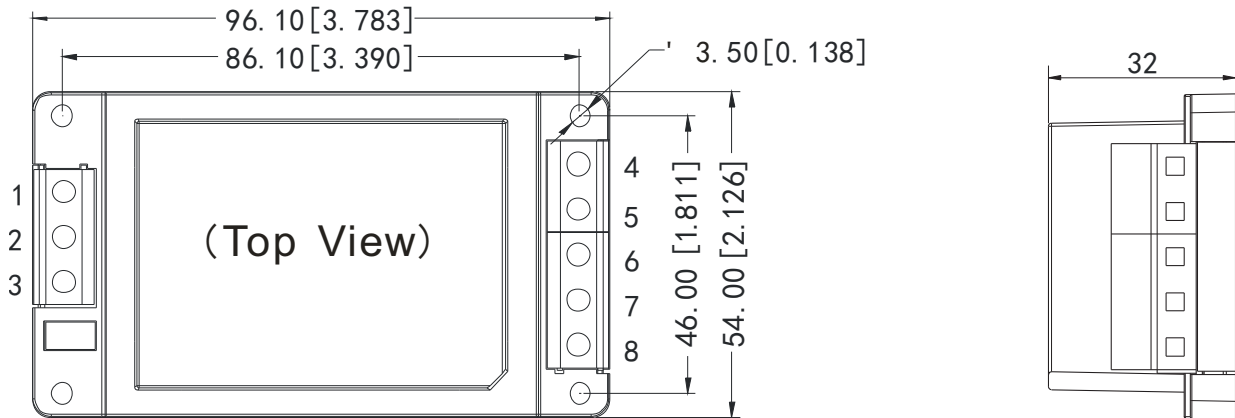

PIN CONNECTIONS	
PIN	FUNCTION
1	GND
2	AC[N]
3	AC[L]
4	-Vo
5	NC
6	TRIM
7	NC
8	+Vo

TYPICAL APPLICATION CIRCUIT

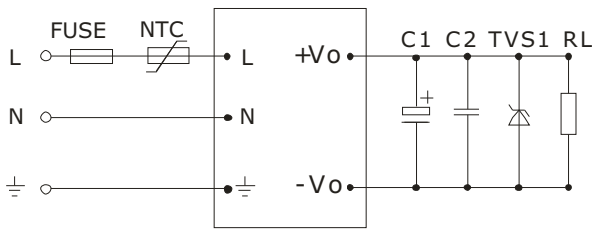

EXTERNAL CAPACITORS TYPICAL VALUE (Unit: μF)	
MODEL	C1
VSK-S20-3R3U-T	330
VSK-S20-5U-T	330
VSK-S20-9U-T	220
VSK-S20-12U-T	220
VSK-S20-15U-T	220
VSK-S20-24U-T	220

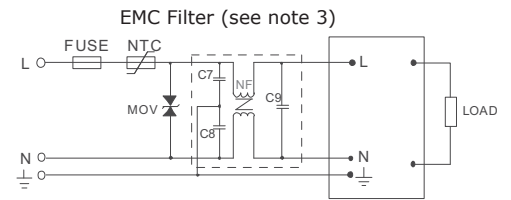

- Notes:
- Output filtering capacitors C1, C2 and C3 are electrolytic capacitors, It is recommended to use high frequency and low impedance electrolytic capacitors. For capacitance and current of capacitor please refer to manufacture's datasheet. Voltage derating of capacitor should be 80% or above. TVS is recommended component to protect post-circuits (if converter fails).
 - 0.1 μF is recommended for C1.
 - If a higher requirement to EMC performance is required it is recommended to add an "EMC filter" at the input end, recommended parameter are as follows:
 MOV: Varistor is used to protect the device under surge.
 C7,C8:Y capacitor, recommended parameter 2200pF/400V;
 C9:X capacitor, recommended parameter 0.1 μF /275V;
 NF: common model choke, recommended inductance is about 10mH-30mH.

TYPICAL EFFICIENCY CURVES

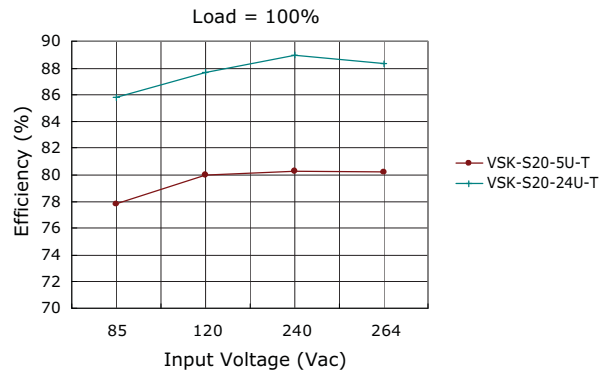
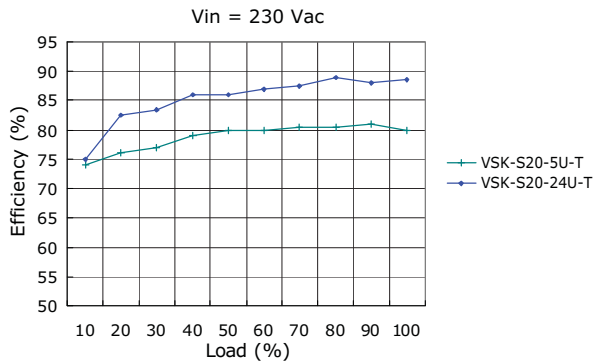

PARALLEL LINES

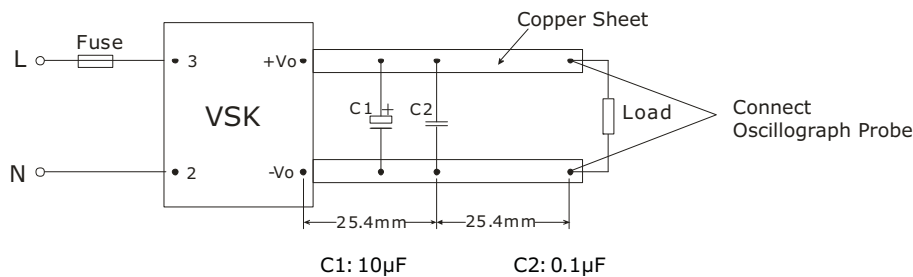

TRIM APPLICATION AND CALCULATION

Application circuit for TRIM
(Part in broken line is the interior of the models)

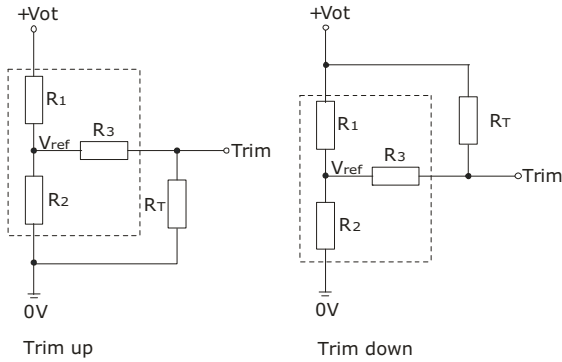

Formula for resistance of Trim

$$\text{up: } R_T = \frac{aR_2}{R_2 - a} - R_3 \quad a = \frac{V_{ref}}{V_{ot} - V_{ref}} \cdot R_1$$

$$\text{down: } R_T = \frac{aR_1}{R_1 - a} - R_3 \quad a = \frac{V_{ot} - V_{ref}}{V_{ref}} \cdot R_2$$

Note: Value for R1, R2, R3 and Vref refer to the following table.

R_T: Resistance of Trim

a: User-defined parameter, no actual meanings.

Vo(V)	3.3	5	12	15	24
Resistance					
R1(KΩ)	2	3.3	3.8	7.5	8.6
R2(KΩ)	1.2	3.3	1	1.5	1
R3(KΩ)	1	1	1	1	1
Vref(V)	1.24	2.5	2.5	2.5	2.5
Vot(V)	Output voltage of Trim, variation ≤ ±10%				

REVISION HISTORY

rev.	description	date
1.0	initial release	09/06/2012

The revision history provided is for informational purposes only and is believed to be accurate.



Headquarters
20050 SW 112th Ave.
Tualatin, OR 97062
800.275.4899

Fax 503.612.2383
cui.com
techsupport@cui.com

CUI offers a two (2) year limited warranty. Complete warranty information is listed on our website.

CUI reserves the right to make changes to the product at any time without notice. Information provided by CUI is believed to be accurate and reliable. However, no responsibility is assumed by CUI for its use, nor for any infringements of patents or other rights of third parties which may result from its use.

CUI products are not authorized or warranted for use as critical components in equipment that requires an extremely high level of reliability. A critical component is any component of a life support device or system whose failure to perform can be reasonably expected to cause the failure of the life support device or system, or to affect its safety or effectiveness.