

FDD12 SERIES

DC - DC CONVERTER
10 ~ 12W SINGLE & DUAL OUTPUT



FEATURES

- LOW COST
- 4:1 WIDE INPUT RANGE
- I/O ISOLATION
- INPUT Pi FILTER
- SHORT CIRCUIT PROTECTION
- HIGH PERFORMANCE
- 3 YEARS WARRANTY

MODEL LIST

MODEL NO.	INPUT VOLTAGE	INPUT CURRENT (typ.)	OUTPUT WATTAGE	OUTPUT VOLTAGE	OUTPUT CURRENT	EFF. (min.)	EFF. (typ.)	CAPACITOR LOAD (max.)
-----------	---------------	----------------------	----------------	----------------	----------------	-------------	-------------	-----------------------

Single Output Models

FDD12 - 03S4	10~36 VDC	0.54 A	10 WATTS	+3.3 VDC	3000 mA	75%	78%	4700 μ F
FDD12 - 05S4	10~36 VDC	0.64 A	12 WATTS	+ 5 VDC	2400 mA	77%	80%	4700 μ F
FDD12 - 12S4	10~36 VDC	0.63 A	12 WATTS	+ 12 VDC	1000 mA	77%	80%	1000 μ F
FDD12 - 15S4	10~36 VDC	0.63 A	12 WATTS	+ 15 VDC	800 mA	77%	80%	470 μ F
FDD12 - 03S5	18~72 VDC	0.26 A	10 WATTS	+3.3 VDC	3000 mA	77%	80%	4700 μ F
FDD12 - 05S5	18~72 VDC	0.32 A	12 WATTS	+ 5 VDC	2400 mA	77%	80%	4700 μ F
FDD12 - 12S5	18~72 VDC	0.32 A	12 WATTS	+ 12 VDC	1000 mA	77%	80%	1000 μ F
FDD12 - 15S5	18~72 VDC	0.32 A	12 WATTS	+ 15 VDC	800 mA	77%	80%	470 μ F

Dual Output Models

FDD12 - 05D4	10~36 VDC	0.64 A	12 WATTS	\pm 5 VDC	\pm 1200 mA	77%	80%	\pm 2200 μ F
FDD12 - 12D4	10~36 VDC	0.64 A	12 WATTS	\pm 12 VDC	\pm 500 mA	77%	80%	\pm 470 μ F
FDD12 - 15D4	10~36 VDC	0.64 A	12 WATTS	\pm 15 VDC	\pm 400 mA	77%	80%	\pm 470 μ F
FDD12 - 05D5	18~72 VDC	0.32 A	12 WATTS	\pm 5 VDC	\pm 1200 mA	77%	80%	\pm 2200 μ F
FDD12 - 12D5	18~72 VDC	0.32 A	12 WATTS	\pm 12 VDC	\pm 500 mA	77%	80%	\pm 470 μ F
FDD12 - 15D5	18~72 VDC	0.32 A	12 WATTS	\pm 15 VDC	\pm 400 mA	77%	80%	\pm 470 μ F

SPECIFICATION

All Specifications Typical At Nominal Line, Full Load, 25°C Unless Otherwise Noticed

GENERAL					
Characteristics	Conditions	min.	typ.	max.	unit
Switching frequency	Vi nom, Io nom		200		KHz
Isolation voltage	Input - Output	1,500			VDC
Isolation resistance	Input - Output, @ 500VDC	100			MΩ
Isolation capacitance	100KHz / 1V			1,000	PF
Ambient temperature	Operating at Vi nom, Io nom	-25		+ 71	°C
Case temperature	Operating at Vi nom, Io nom			+ 100	°C
Derating	Vi nom	See derating curve			
Storage temperature	Non operational	-40		+ 100	°C
Relative humidity	Vi nom, Io nom	20		95	% RH
Temperature coefficient	Vi nom, Io min			± 0.02	% / °C
Dimension		L50.8 x W50.8 x H12.0			mm
MTBF	Belcore issue 6@40°C, GB		1,040,000		Hours
Cooling	Free air convection				

INPUT SPECIFICATIONS					
Characteristics	Conditions	min.	typ.	max.	unit
Input voltage range	Ta min ... Ta max, Io nom	10	24	36	VDC
		18	48	72	VDC
No load input current	Vi nom, Io = 0	24V		20	mA
		48V		15	mA
Input voltage w/o damage	Io nom	24V		40	VDC
		48V		75	VDC
Startup voltage	Io nom	24V	9		VDC
		48V	15		VDC
Input filter	Pi type				

OUTPUT SPECIFICATIONS					
Characteristics	Conditions	min.	typ.	max.	unit
Output voltage accuracy	Vi nom, Io nom			± 2	%
Minimum load	Vi nom	0			%
	single output models dual output models (each output)	20			%
Line regulation	Io nom, Vi min ... Vi max			± 1	%
Load regulation	Vi nom, Io 0 ... Io nom, single output models			± 2	%
	Vi nom, Io min ... Io nom, dual output models			± 5	%
Cross regulation (Dual model)	Aymmetrical load 20% - 100% FL			± 5	%
Startup time	Vi nom, Io nom			30	ms
Transient recovery time	Vi nom, I ~ 0.5 Io nom			500	μs
Ripple & noise	Vi nom, Io nom, BW = 20MHz	3.3V		100	mV
		5V, 12V, 15V & dual		Vout x ± 1%	mV
Efficiency	Vi nom, Io nom, Po / Pi	Up to 80%, See model list and efficiency curve			

CONTROL AND PROTECTION	
Input reversed	Shunt diode built in, external fuse recommended (24Vin : 1.5A, 48Vin : 1A)
Output short circuit	Current limited (Auto-recovery)
Rated over load protection	110%min....140%max

PHYSICAL CHARACTERISTICS

Case size	50.8 x 50.8 x 12.0 mm (2 x 2 x 0.47 inches)
Case material	Plastic base / Metal case
Weight	70 g
Potting material	Epoxy

MECHANISM & PIN CONFIGURATION

mm [inch]

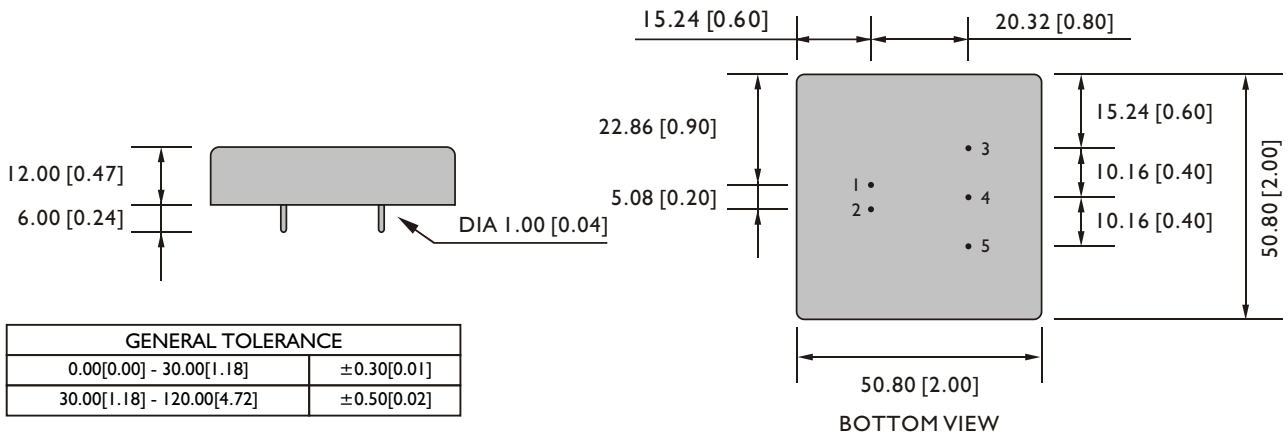

PIN ASSIGNMENT

GENERAL

PIN NO.	1	2	3	4	5
SINGLE	Vi+	Vi-	Vo+	NO PIN	Vo-
DUAL	Vi+	Vi-	Vo+	com	Vo-

CIRCUIT SCHEMATIC

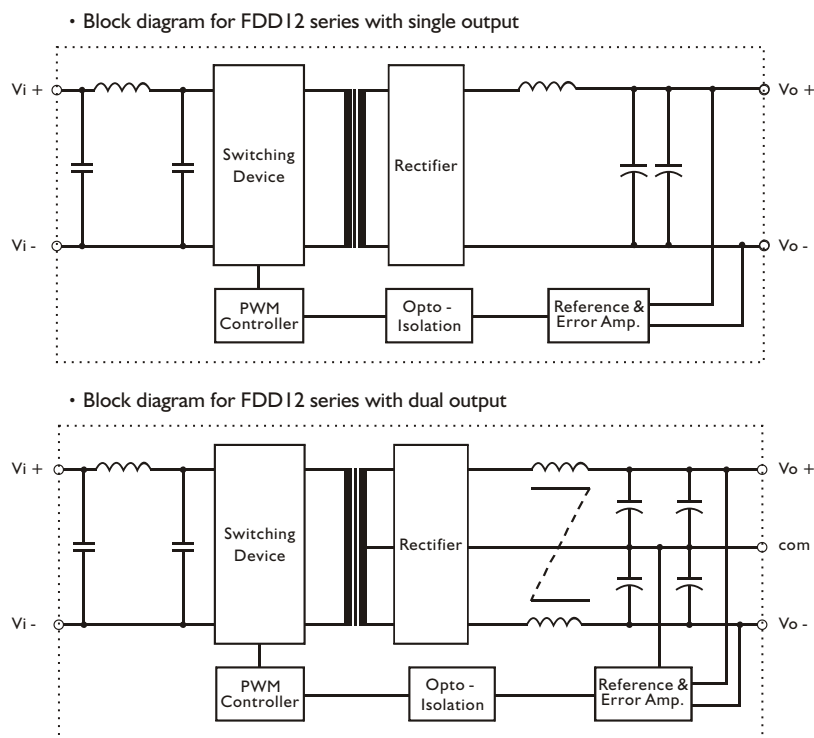

RECOMMENDED CIRCUIT

- Recommended filter for EN55022 Class B compliance

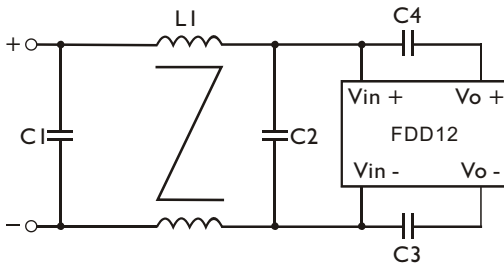

- The components used in the above figure, together with the manufacturer part numbers for these components, are as follows.

	C1	C2	C3	C4	L1
FDD12-XXX4	4.7 μ F / 50V MLCC	4.7 μ F / 50V MLCC	1nF / 2KV MLCC	1nF / 2KV MLCC	0.5mH Common Choke
FDD12-XXX5	6.8 μ F / 100V MLCC	6.8 μ F / 100V MLCC	1nF / 2KV MLCC	1nF / 2KV MLCC	0.5mH Common Choke

- Recommended EN 55022 Class B filter circuit layout.

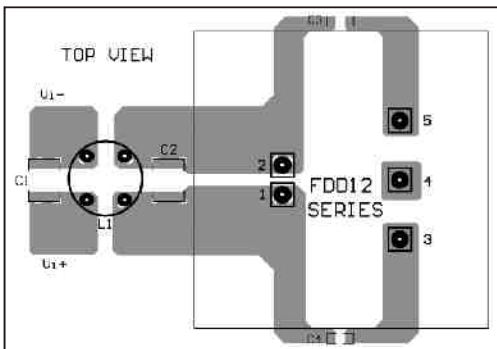

DERATING AND EFFICIENCY CURVE

Temperature derating curve

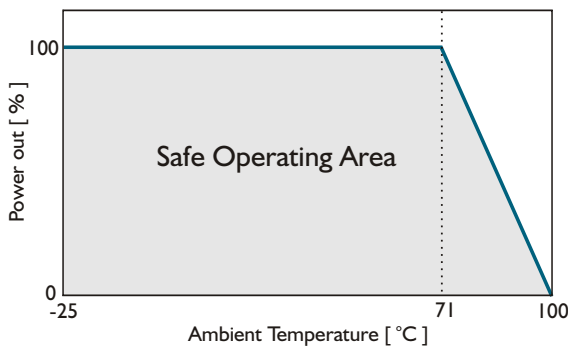

Efficiency Vs Input Voltage
FDD12-05S4

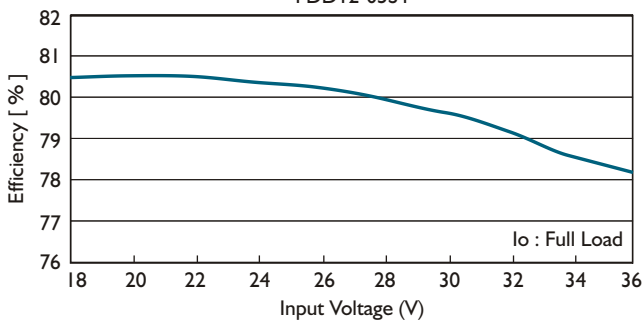

Efficiency Vs Output Load
FDD12-05S4

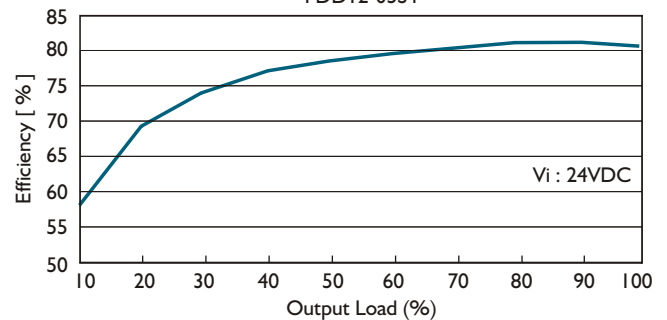

SPECIFICATION

All Specifications Typical At Nominal Line, Full Load, 25°C Unless Otherwise Noticed

GENERAL					
Characteristics	Conditions	min.	typ.	max.	unit
Switching frequency	Vi nom, Io nom		200		KHz
Isolation voltage	Input - Output	1,500			VDC
Isolation resistance	Input - Output, @ 500VDC	100			MΩ
Isolation capacitance	100KHz / 1V			1,000	PF
Ambient temperature	Operating at Vi nom, Io nom	-25		+ 71	°C
Case temperature	Operating at Vi nom, Io nom			+ 100	°C
Derating	Vi nom	See derating curve			
Storage temperature	Non operational	-40		+ 100	°C
Relative humidity	Vi nom, Io nom	20		95	% RH
Temperature coefficient	Vi nom, Io min			± 0.02	% / °C
Dimension		L50.8 x W50.8 x H12.0			mm
MTBF	Belcore issue 6@40°C, GB		960,000		Hours
Cooling	Free air convection				

INPUT SPECIFICATIONS					
Characteristics	Conditions	min.	typ.	max.	unit
Input voltage range	Ta min ... Ta max, Io nom	10	24	36	VDC
		18	48	72	VDC
No load input current	Vi nom, Io = 0	24V		25	mA
		48V		15	mA
Input voltage w/o damage	Io nom	24V		40	VDC
		48V		75	VDC
Startup voltage	Io nom	24V	9.4		VDC
		48V	15		VDC
Input filter	Pi type				

OUTPUT SPECIFICATIONS					
Characteristics	Conditions	min.	typ.	max.	unit
Output voltage accuracy	Vi nom, Io nom	+ 5V		± 2	%
		± 12V or ± 15V		± 6	%
Minimum load	Vi nom	+ 5V	10		%
		± 12V or ± 15V	20		%
Line regulation	Io nom, Vi min ... Vi max			± 2	%
Load regulation	Vi nom, Io min...Io nom	+ 5V		± 2	%
		± 12V or ± 15V		± 6	%
Cross regulation	Aymmetrical load 20% - 100% FL			± 6	%
Startup time	Vi nom, Io nom			30	ms
Transient recovery time	Vi nom, I ~ 0.5 Io nom			500	μs
Ripple & noise	Vi nom, Io nom, BW = 20MHz			Vout x ± 1%	mV
Efficiency	Vi nom, Io nom, Po / Pi	Up to 82%, See model list and efficiency curve			

CONTROL AND PROTECTION	
Remote ON / OFF	ON : opened or 8 ~ 10VDC applied, reference to input GND OFF : -0.3 ~ 2VDC applied, reference to input GND
Input reversed	Shunt diode built in, external fuse recommended (24Vin : 1.5A, 48Vin : 1A)
Output short circuit	Current limited (Auto-recovery)
Rated over load protection	110%min....140%max

PHYSICAL CHARACTERISTICS

Case size	50.8 x 50.8 x 12.0 mm (2 x 2 x 0.47 inches)
Case material	Plastic base / Metal case
Weight	70 g
Potting material	Epoxy

MECHANISM & PIN CONFIGURATION

mm [inch]

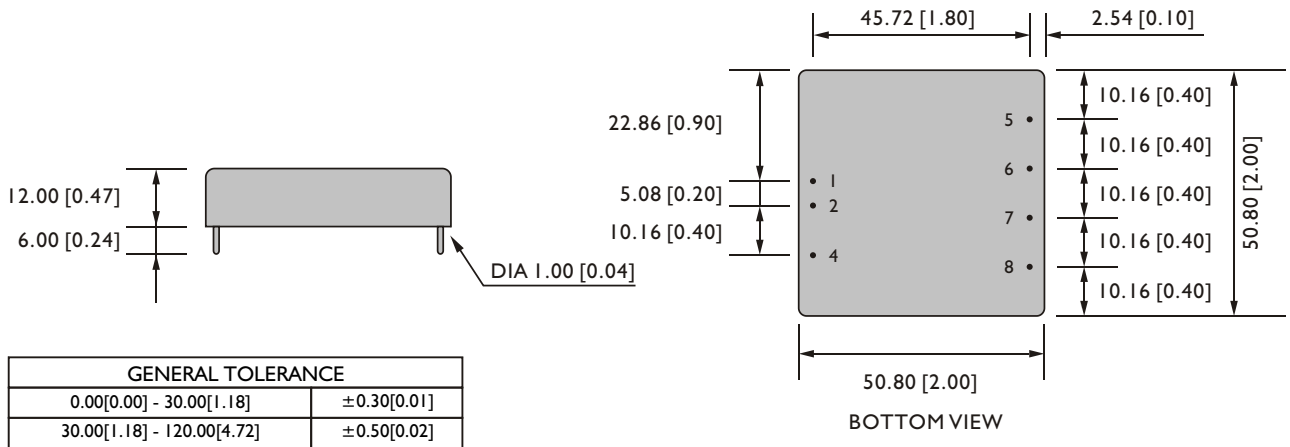

PIN ASSIGNMENT

GENERAL

PIN NO.	1	2	4	5	6	7	8
TRIPLE	Vi+	Vi-	ON / OFF	Vo2 (+ OUT)	Vo1 (+ 5V)	com	Vo3 (- OUT)

CIRCUIT SCHEMATIC

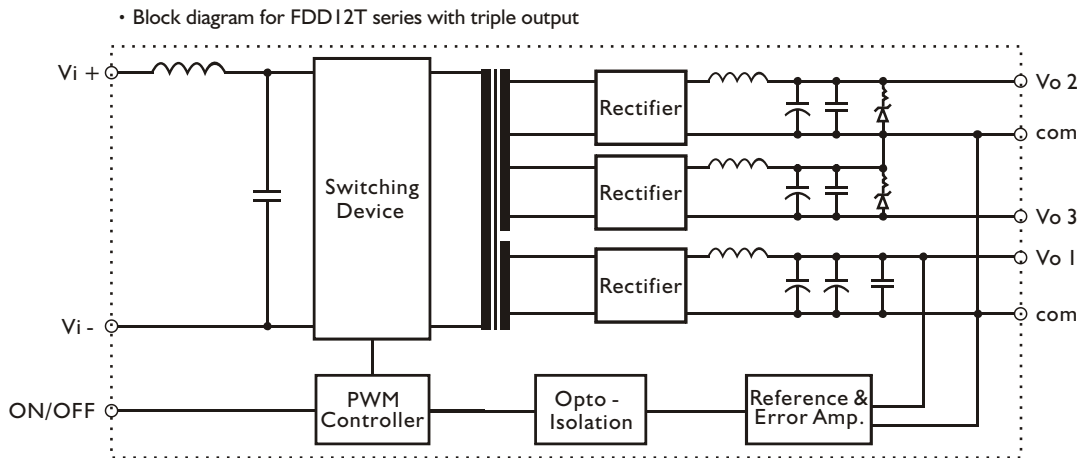

RECOMMENDED CIRCUIT

- Recommended filter for EN55022 Class B compliance

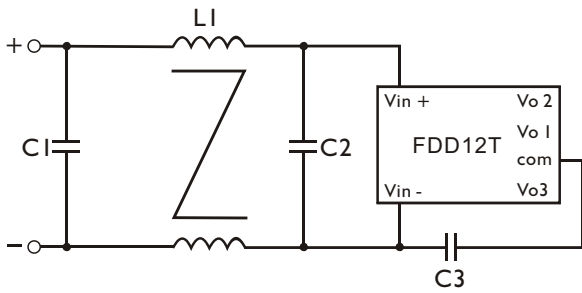

- The components used in the above figure, together with the manufacturer part numbers for these components, are as follows.

	C1	C2	C3	L1
FDD12-XXXXT4	3.3 μ F / 50V MLCC	3.3 μ F / 50V MLCC	1nF / 2KV MLCC	0.5mH Common Choke
FDD12-XXXXT5	3.3 μ F / 100V MLCC	3.3 μ F / 100V MLCC	1nF / 2KV MLCC	0.5mH Common Choke

- Recommended EN 55022 Class B filter circuit layout.

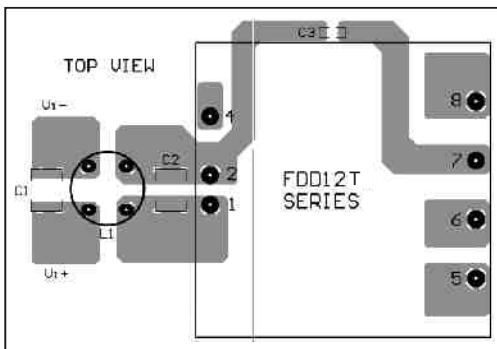

DERATING AND EFFICIENCY CURVE

Temperature derating curve

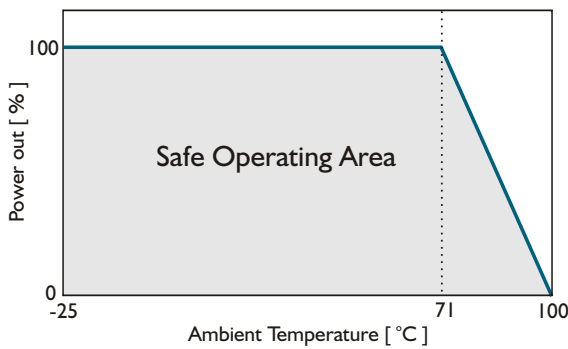

Efficiency Vs Input Voltage
FDD12-0515T4

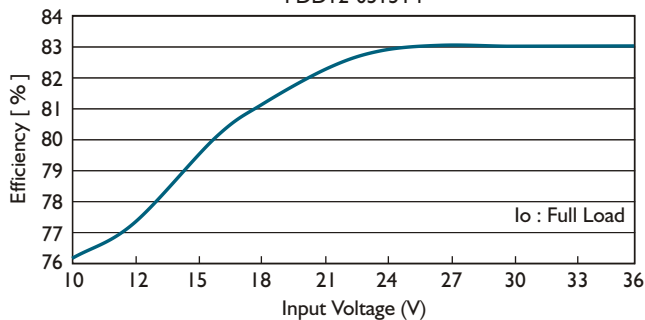

Efficiency Vs Output Load
FDD12-0515T4

