

P10RG-xxxxE/Z4:1LF



PMBW-SERIES

Rev.04-2009

- ✓ 2 Watt
- ✓ 4:1 Ultra Wide Input
- ✓ **Reg. Single and Dual Output**
- ✓ 1.5 kV DC I/O Isolation
- ✓ **SIP9** case
- ✓ **On/Off Control**
- ✓ Contin. Short Circuit Protection

The PMBW 2Watt series is a family of cost effective DCDC converters with 4:1 ultra wide input, 2W single and dual output DC/DC converters with control Pin. These converters are encapsulated in an ultra miniature SIP9 plastic case. High performance features: continuous / long time short circuit protection with automatic restart and tight line / load regulation, high efficiency operation and output voltage accuracy of $\pm 2\%$ maximum.

All specifications typical at $T_a=25^\circ\text{C}$, nominal input voltage and full load unless otherwise specified

Input Specifications

Voltage Range	4:1 Ultra Wide Input (see table)
Input Filter	Capacitor
Input Reflected Ripple Current ¹	20 mA pk-pk
Start-up Time	10 mS, typ.

Output Specifications

Voltage Accuracy	$\pm 1\%$
Short Circuit Protection	Indefinite (hiccup, Automatic Recovery)
Line Regulation	$\pm 0.5\%$
Load Regulation (0% - 100%)	$\pm 0.5\%$, max. (<10% load: $\pm 1\%$ for 3.3Vout and 5Vout)
Cross Regulation (Dual Output)	$\pm 5\%$
Ripple and Noise (20Mhz bandwidth)	50 mV pk-pk
Temperature Coefficient	$\pm 0.02\% / ^\circ\text{C}$
Transient Recovery Time ³	300 us, typ.
Transient Response Deviation ³	$\pm 3\%$, max.

General Specifications

I/O Isolation Voltage (3 sec.)	1500 VDC
I/O Isolation Capacity	500 pF, max.
I/O Isolation Resistance	1000 M Ohm
Switching Frequency	250 kHz
Humidity	95% rel H
Reliability Calculated MTBF (MIL-HDBK-217F)	> 1.212 Mhrs

Physical Specifications

Case Material	Non Conductive Black Plastic (UL94V-0 rated)
Potting Material	Epoxy (UL94V-0 rated)
Weight	~ 6.5 g, typ.

Environment Specifications

Operating Temperature	-40 to +75 $^\circ\text{C}$ (ambient)
Maximum Case Temperature	100 $^\circ\text{C}$
Storage Temperature	-40 to +125 $^\circ\text{C}$
Cooling	Free Air Convection (10mm distance required)
RoHS Conform	Soldering 260 $^\circ\text{C}$, max. (1.5mm from case 10s.)

Selection Guide

Single/Dual Output

Order #	Input Voltage (VDC)	Input Current No Load (mA)	Input Current Full Load (mA)	Output Voltage (VDC)	Output Current Min. Load (mA)	Output Current Full Load (mA)	Efficiency (%)	Capacitor Load (uF) ²
SINGLE OUTPUT								
P10RG-243R3E4:1LF	9-36	10	92	3.3	0	500	75	2200
P10RG-2405E4:1LF	9-36	10	103	5	0	400	81	1000
P10RG-2412E4:1LF	9-36	10	100	12	0	165	84	165
P10RG-2415E4:1LF	9-36	10	98	15	0	135	85	100
P10RG-483R3E4:1LF	18-72	5	46	3.3	0	500	75	2200
P10RG-4805E4:1LF	18-72	5	53	5	0	400	80	1000
P10RG-4812E4:1LF	18-72	5	50	12	0	165	84	165
P10RG-4815E4:1LF	18-72	5	50	15	0	135	84	100

Order #	Input Voltage (VDC)	Input Current No Load (mA)	Input Current Full Load (mA)	Output Voltage (VDC)	Output Current Min. Load (mA)	Output Current Full Load (mA)	Efficiency (%)	Capacitor Load (uF) ²
DUAL OUTPUT								
P10RG-2405Z4:1LF	9-36	10	103	± 5	0	± 200	81	± 470
P10RG-2412Z4:1LF	9-36	10	101	± 12	0	± 85	83	± 100
P10RG-2415Z4:1LF	9-36	15	102	± 15	0	± 65	82	± 47
P10RG-4805Z4:1LF	18-72	5	53	± 5	0	± 200	80	± 470
P10RG-4812Z4:1LF	18-72	5	52	± 12	0	± 85	81	± 100
P10RG-4815Z4:1LF	18-72	5	50	± 15	0	± 65	84	± 47

If you need other specifications, please enquire.

Package / Pinning / Derating

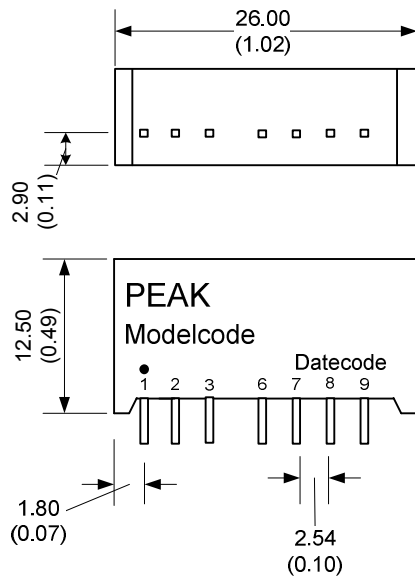

All dimensions are typical in millimeters (inches).
 - Pin diameter: 1.0 +/-0.05 (0.04 +/-0.002)
 - Pin pitch tolerance: +/-0.35 (+/-0.014)
 - Case tolerance +/-0.5 (+/-0.02)
 Specification may change without notice.

SIP9 – PLASTIC CASE

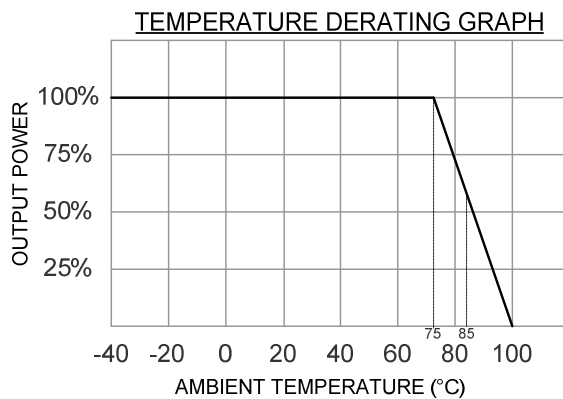
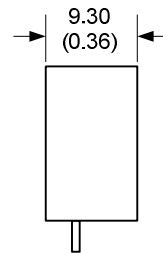

PIN CONNECTIONS		
#	SINGLE	DUAL
1	- Vin	- Vin
2	+Vin	+Vin
3	Ctrl.	Ctrl.
6	+Vout	+Vout
7	N.C.	Common
8	N.C.	N.C.
9	- Vout	- Vout

App Notes:

- 1 = Measured Input reflected ripple current with a simulated source inductance of 12uH
- 2 = Tested by nominal Vin and constant resistive load.
- 3 = Test by normal Vin and 100%-25% load, 25% load step change; If Vout is 3.3V then the Transient Response Deviation is ±5%.
- 4 = Input filter components are required to help meet conducted emission class A
- 5 = An external filter capacitor is required to meet EN61000-4-4 and EN61000-4-5. (e.g. Nippon-chemi-con KY series, 220uF/100V)

EMC SPECIFICATIONS		
Conducted Emissions ⁴	EN 55022	CLASS A
Radiated Emissions	EN 55022	CLASS A
ESD	IEC 61000-4-2	Perf. Criteria B
RS	IEC 61000-4-3	Perf. Criteria A
EFT ⁵	IEC 61000-4-4	Perf. Criteria B
Surge ⁵	IEC 61000-4-5	Perf. Criteria B
CS	IEC 61000-4-6	Perf. Criteria A
PFMF	IEC 61000-4-8	Perf. Criteria A

Remote ON/OFF

The MCU Pin Voltage is referenced to -Vin (Pin1)
 ON: 0 – 0.6 VDC or open circuit
 OFF: 2.7 - 15 VDC
 OFF stand by input current: 5mA, max.

App Notes

Test Configurations

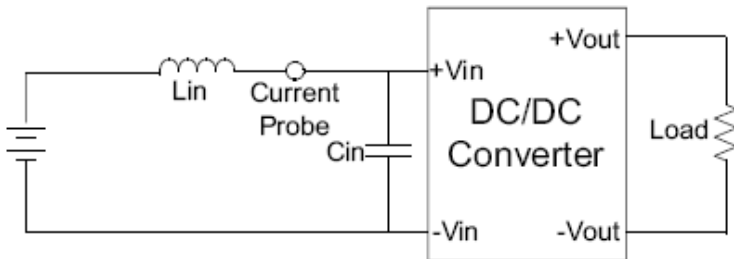

Input Reflected Ripple Current Test Step

Input reflected ripple current is measured through a source inductor L_{in} (12 μ H) and a source capacitor C_{in} (47 μ F, ESR < 1.0 Ω at 100KHz) at nominal input and full load.

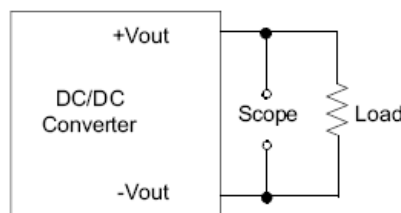

Output Ripple & Noise Measurement Test

The Scope measurement bandwidth is 20MHz.

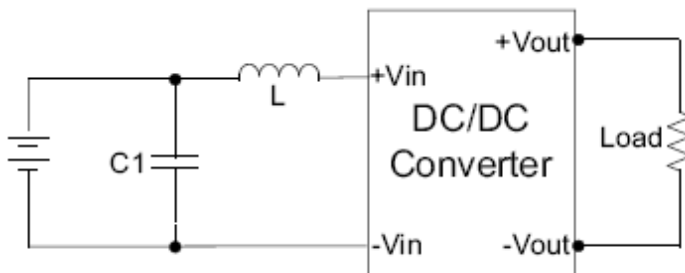

EMI Filter

Input filter components (C_1 , L) are used to help meet conducted emissions requirement for the module. These components should be mounted as close as possible to the module; and all leads should be minimized to decrease radiated noise.

Input Components		
	C1	L
P10RG-24xx	1210, 225k/100V, X7R (2pcs)	6.8 μ H
P10RG-48xx	1210, 105k/100V, X7R	56 μ H